



ARTHROSCOPY

REDA

INSTRUMENTE GMBH

Reda Instrumente GmbH
Gänsäcker 34 - P.O. Box 131
D-78532 Tuttlingen

Telefon +49/7462/9445-0
Telefax +49/7462/9445-20
e-mail: info@Reda-Instrumente.de
<http://www.Reda-Instrumente.de>

Ausgabe Nr. 3
Datum: 2016

Endoskope für Arthroskopie
Endoscopes for Arthroscopy
Endoscopios para artroscopía

Ø 4 mm

Arthroskop, autoklavierbar mit integrierter Faser zur Beleuchtung für diagnostische und operative Eingriffe, Ø 4 mm, Arbeitslänge 175 mm:
Knie, Perkutane Nucleotomie, lumbaler Bandscheibenvorfall, für Schulter-Arthroskopie.

Arthroscope, autoclavable, with integrated fiber optic for illumination, for diagnostic and operation, Ø 4 mm, working length 175 mm:
Knee, percutaneous nucleotomy, shoulder arthroscopy.

Artroscopios (ópticas) autoclavables con fibraoptica incorporado para intervenciones diagnósticas y operativas, diámetro de 4 mm, largo útil 175 mm:
rodilla, nucleotomía percutanea, hernias lumbales y artroscopía de la espalda y hombro.

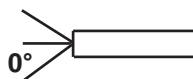
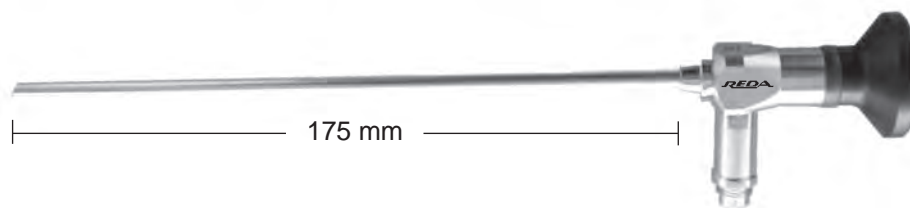

0°

Geradeausblick
Direct vision
Vision directa

R400-040175-000

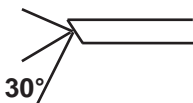

30°

Vorausblick
Foroblique vision
ángulo de

R400-040175-030

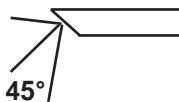

45°

Vorausblick
Foroblique vision
ángulo de

R400-040175-045

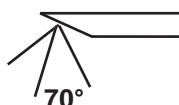

70°

Seitblick
Lateral vision
ángulo de

R400-040175-070

Arthroskopieschäfte für Endoskope mit Ø 4 mm
 Arthroscopy Sheath for endoscopes with Ø 4 mm
 Vainas para artroscopia para endoscopios de Ø 4 mm

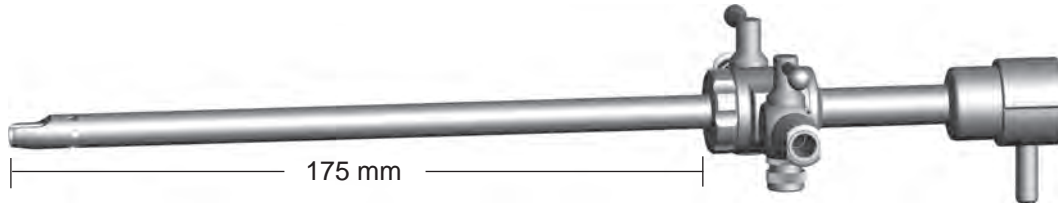

30°



universal

Trokar-Hülse mit zwei Spülhähnen, drehbar, 4 mm Ø
 Trocar sleeve, with two stop cocks rotating, 4 mm Ø
 Tubo con dos llaves giratorias, de 4 mm Ø

R414-040175-030

R414-040175-070

mit einem Spülhahn drehbar
 with one stop cock rotating
 con una llave giratoria

R413-040175-030

R413-040175-070

Obturator 4 mm Ø
Obturator 4 mm Ø
Obturador de 4 mm Ø



scharf / sharp / agudo

R410-040175-001



konisch stumpf / conical blunt / cónico romo

R410-040175-002



stumpf / blunt / romo

R410-040175-003

Arthroskopieschäfte für Endoskope mit Ø 4 mm, High Flow
Arthroscopy Sheath for endoscopes with Ø 4 mm , High Flow
Vainas para artroscopia para endoscopios de Ø 4 mm , High Flow

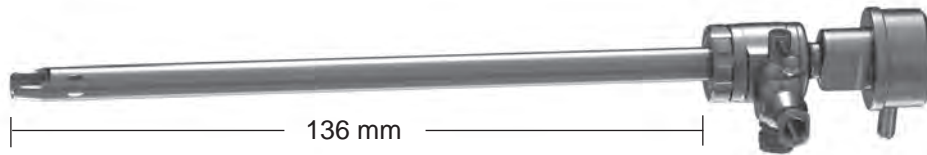

30°



universal

Trokar-Hülse mit zwei Spülhähnen, drehbar, 4 mm Ø
Trocar sleeve, with two stop cocks rotating, 4 mm Ø
Tubo con dos llaves giratorias, de 4 mm Ø

R414-040136-030

R414-040136-070

mit einem Spülhahn drehbar
with one stop cock rotating
con una llave giratoria

R413-040136-030

R413-040136-070

Obturator 4 mm Ø
Obturator 4 mm Ø
Obturador de 4 mm Ø



scharf / sharp / agudo

R411-040136-001



konisch stumpf / conical blunt / cónico romo

R411-040136-002



stumpf / blunt / romo

R411-040136-003

Stryker

Arthroskopieschäfte für Endoskope mit Ø 4 mm, High Flow
 Arthroscopy Sheath for endoscopes with Ø 4 mm, High Flow
 Vainas para artroscopia para endoscopios de Ø 4 mm, High Flow

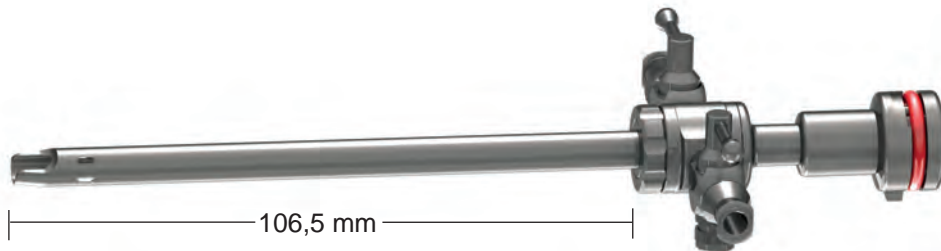

30°



universal

Trokar-Hülse mit zwei Spülhähnen, drehbar, 4 mm Ø
 Trocar sleeve, with two stop cocks rotating, 4 mm Ø
 Tubo con dos llaves giratorias, de 4 mm Ø

R414-040106-030

R414-040106-070

mit einem Spülhahn drehbar
 with one stop cock rotating
 con una llave giratoria

R413-040106-030

R413-040106-070

Obturator 4 mm Ø
Obturator 4 mm Ø
Obturador de 4 mm Ø



scharf / sharp / agudo

R411-040106-001



konisch stumpf / conical blunt / cónico romo

R411-040106-002

Arthroskopieschäfte für Endoskope mit Ø 4 mm, High Flow
 Arthroscopy Sheath for endoscopes with Ø 4 mm, High Flow
 Vainas para artroscopia para endoscopios de Ø 4 mm, High Flow

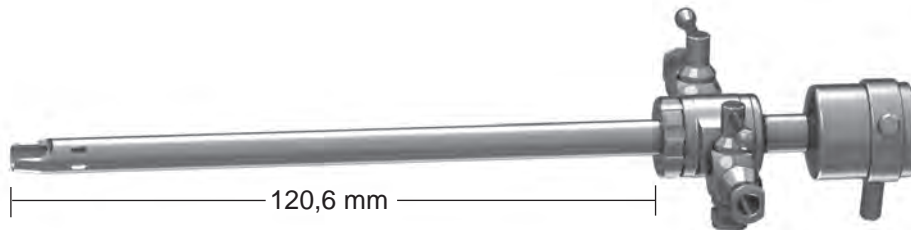

30°



universal

Trokar-Hülse mit zwei Spülhähnen, drehbar, 4 mm Ø
 Trocar sleeve, with two stop cocks rotating, 4 mm Ø
 Tubo con dos llaves giratorias, de 4 mm Ø

R414-040120-030

R414-040120-070

mit einem Spülhahn drehbar
 with one stop cock rotating
 con una llave giratoria

R413-040120-030

R413-040120-070

Obturator 4 mm Ø
Obturator 4 mm Ø
Obturador de 4 mm Ø
Otturatore 4 mm Ø



scharf / sharp / agudo

R411-040120-001



konisch stumpf / conical blunt / cónico romo

R411-040120-002

Endoskope für Arthroskopie
Endoscopes for Arthroscopy
Endoscopios para artroscopía

Ø 2,7 mm

Arthroskop, autoklavierbar mit integrierter Faser zur Beleuchtung für diagnostische und operative Eingriffe,
Ø 2,7 mm, Arbeitslänge 110 mm:
Kleine Gelenke und Karpaltunnel

Arthroscope, autoclavable, with integrated fiber optic for illumination, for diagnostic and operation,
Ø 2.7 mm, working length 110 mm:
small joints and carpal tunnel

Artroscopios (ópticas) autoclavables con fibraoptica incorporado para intervenciones diagnósticas y operativas,
diámetro de 2,7 mm, largo útil 110 mm:
articulaciones pequeñas

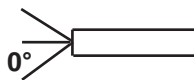
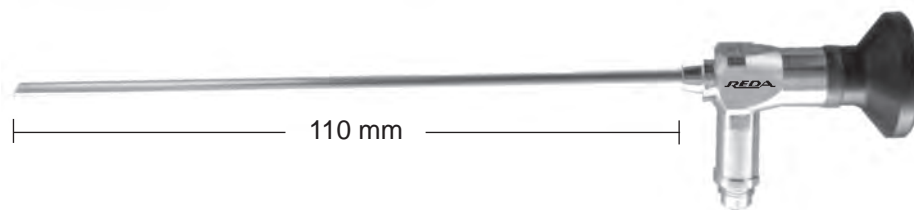

Geradeausblick
Direct vision
Vision directa

R400-027110-000

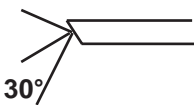

Vorausblick
Foroblique vision
ángulo de

R400-027110-030

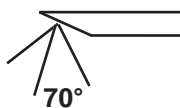

Seitblick
Lateral vision
ángulo de

R400-027110-070

Arthroskopieschäfte für Endoskope mit Ø 2,7 mm
 Arthroscopy Sheath for endoscopes with Ø 2,7 mm
 Vainas para artroscopia para endoscopios de Ø 2,7 mm

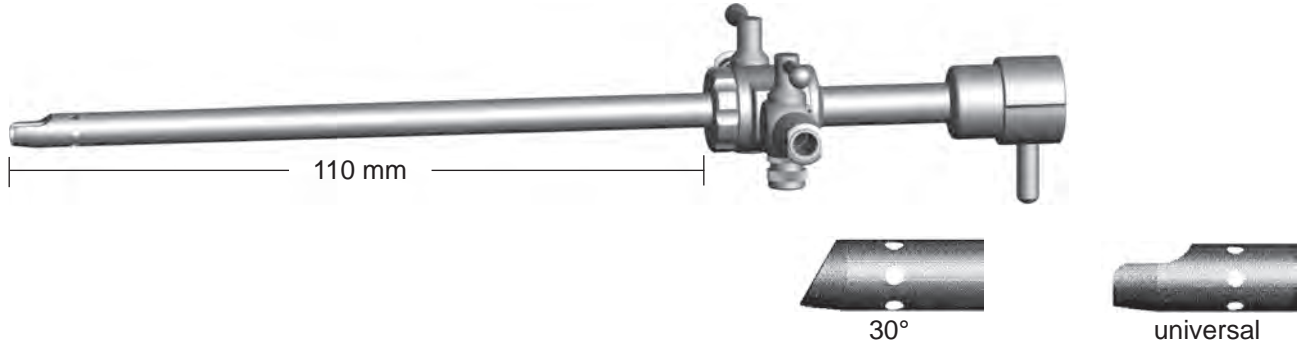

Trokar-Hülse mit zwei Spülhähnen, drehbar, 2,7 mm Ø
 Trocar sleeve, with two stop cocks rotating, 2.7 mm Ø
 Tubo con dos llaves giratorias, de 2,7 mm Ø

R414-027110-030

R414-027110-070

mit einem Spülhahn drehbar
 with one stop cock rotating
 con una llave giratoria

R413-027110-030

R413-027110-070

Obturator 2,7 mm Ø
Obturator 2.7 mm Ø
Obturador de 2,7 mm Ø



scharf / sharp / agudo

R410-027110-001



konisch stumpf / conical blunt / cónico romo

R410-027110-002



stumpf / blunt / romo

R410-027110-003

Endoskope für Arthroskopie
Endoscopes for Arthroscopy
Endoscopios para artroscopía

Ø 2,7 mm

Arthroskop, autoklavierbar mit integrierter Faser zur Beleuchtung für diagnostische und operative Eingriffe,
Ø 2,7 mm, Arbeitslänge 175 mm:
Kleine Gelenke

Arthroscope, autoclavable, with integrated fiber optic for illumination, for diagnostic and operation,
Ø 2.7 mm, working length 175 mm:
small joint

Artroscopios (ópticas) autoclavables con fibraoptica incorporado para intervenciones diagnósticas y operativas,
diámetro de 2,7 mm, largo útil 175 mm:
articulaciones pequeñas

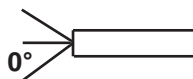
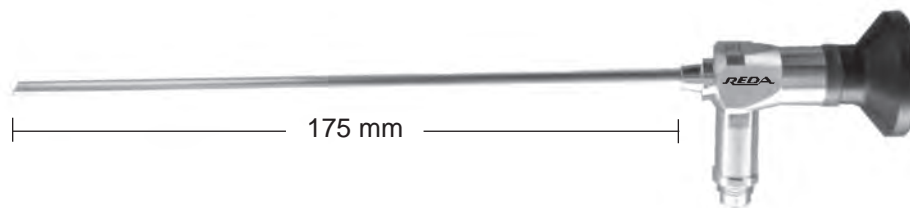

Geradeausblick
Direct vision
Vision directa

R400-027175-000

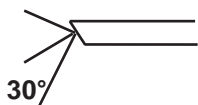

Vorausblick
Foroblique vision
ángulo de

R400-027175-030



Seitblick
Lateral vision
ángulo de

R400-027175-070

Arthroskopieschäfte für Endoskope mit Ø 2,7 mm
 Arthroscopy Sheath for endoscopes with Ø 2,7 mm
 Vainas para artroscopia para endoscopios de Ø 2,7 mm

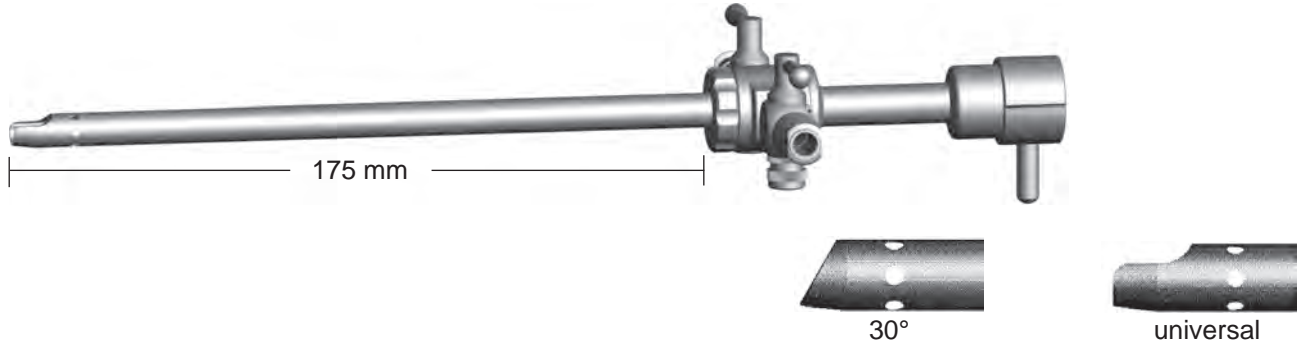

Trokar-Hülse mit zwei Spülhähnen, drehbar, 2,7 mm Ø
 Trocar sleeve, with two stop cocks rotating, 2.7mm Ø
 Tubo con dos llaves giratorias, de 2,7 mm Ø

R414-027175-030

R414-027175-070

mit einem Spülhahn drehbar
 with one stop cock rotating
 con una llave giratoria

R413-027175-030

R413-027175-070

Obturator 2,7 mm Ø
Obturator 2.7 mm Ø
Obturador de 2,7 mm Ø



scharf / sharp / agudo

R410-027175-001



konisch stumpf / conical blunt / cónico romo

R410-027175-002



stumpf / blunt / romo

R410-027175-003

Endoskope für Arthroskopie
Endoscopes for Arthroscopy
Endoscopios para artroscopía

Ø 2,7 mm

Arthroskop, autoklavierbar mit integrierter Faser zur Beleuchtung für diagnostische und operative Eingriffe,
Ø 2,7 mm, Arbeitslänge 188 mm:
Schulter

Arthroscope, autoclavable, with integrated fiber optic for illumination, for diagnostic and operation,
Ø 2.7 mm, working length 188 mm:
shoulder

Artroscopios (ópticas) autoclavables con fibraoptica incorporado para intervenciones diagnósticas y operativas,
diámetro de 2,7 mm, largo útil 188 mm:
hombro

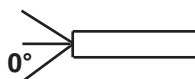
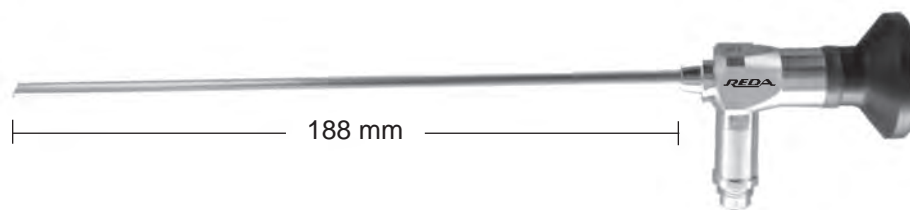

Geradeausblick
Direct vision
Vision directa

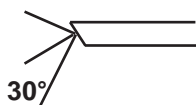
R400-027188-000

Vorausblick
Foroblique vision
ángulo de

R400-027188-030

Seitblick
Lateral vision
ángulo de

R400-027188-070

Arthroskopieschäfte für Endoskope mit Ø 2,7 mm
 Arthroscopy Sheath for endoscopes with Ø 2,7 mm
 Vainas para artroscopia para endoscopios de Ø 2,7 mm

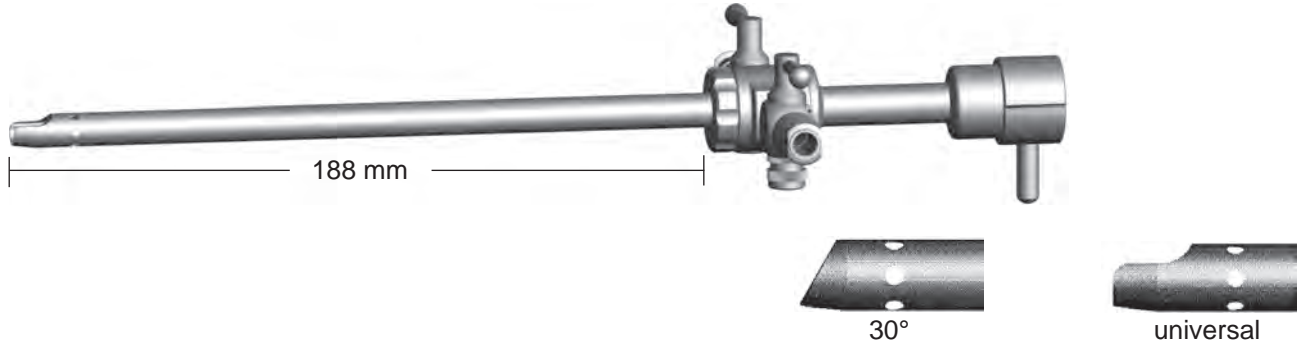

Trokar-Hülse mit zwei Spülhähnen, drehbar, 2,7 mm Ø
 Trocar sleeve, with two stop cocks rotating, 2.7mm Ø
 Tubo con dos llaves giratorias, de 2,7 mm Ø

R414-027188-030

R414-027188-070

mit einem Spülhahn drehbar
 with one stop cock rotating
 con una llave giratoria

R413-027188-030

R413-027188-070

Obturator 2,7 mm Ø
Obturator 2.7 mm Ø
Obturador de 2,7 mm Ø



scharf / sharp / agudo

R410-027188-001



konisch stumpf / conical blunt / cónico romo

R410-027188-002



stumpf / blunt / romo

R410-027188-003

Hakenstanze, mit Schippe
 Hook punch, scoope nose
 Pinza cortante, de nariz aguda

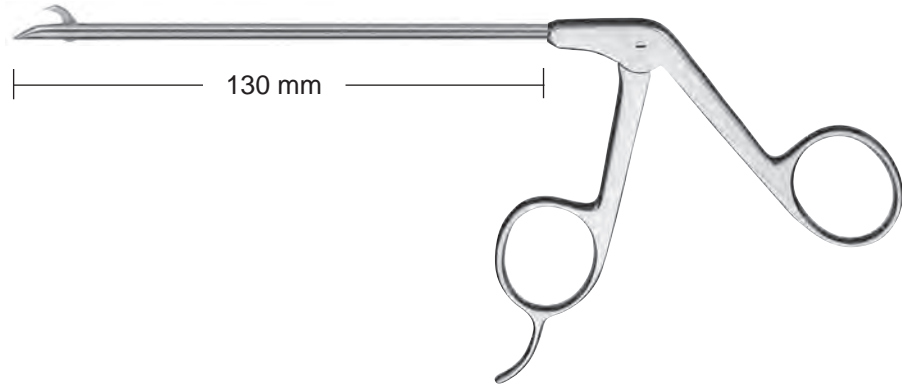

3,4 mm Ø
 cutting size 5 x 1,6

2,8 mm Ø
 cutting size 4 x 1,2

Hakenstanze mit Schippe
 Hook punch, scoope nose
 Pinza cortante, de nariz aguda



gerade / straight / recta

R440-034130-000

R440-028130-000



30°

Schaft gebogen / shaft curved
 vaina curva:

rechts / right / derecha

R440-034130-030

R440-028130-030

links / left / izquierda

R440-034130-130

R440-028130-130



45°

rechts / right / derecha

R440-034130-045

R440-028130-045

links / left / izquierda

R440-034130-145

R440-028130-145



7°

aufwärts / upwards
 hacia arriba

R440-034130-007

R440-028130-007



abwärts / downwards
 hacia abajo

R440-034130-107

R440-028130-107



15°

aufwärts / upwards
 hacia arriba

R440-034130-015

R440-028130-015



abwärts / downwards
 hacia abajo

R440-034130-115

R440-028130-115

Hakenstanze, mit Schippe 15°
 Hook punch, scoope nose 15°
 Pinza cortante, de nariz aguda 15°

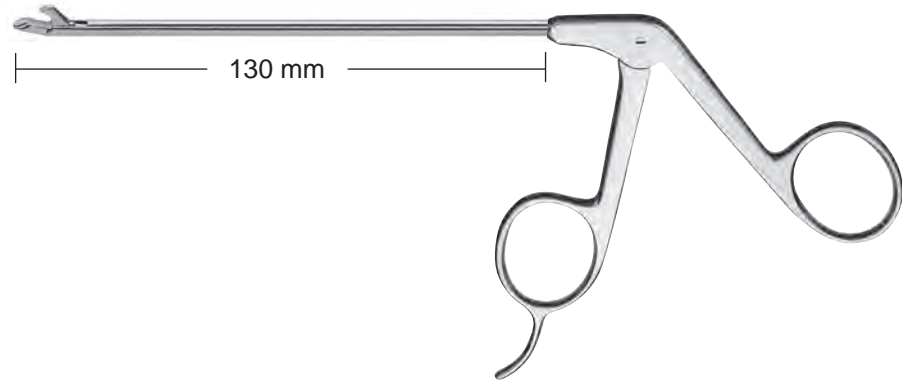

3,4 mm Ø
 cutting size 5 x 1,6

2,8 mm Ø
 cutting size 4 x 1,2

Hakenstanze mit Schippe
 Hook punch, scoope nose
 Pinza cortante, de nariz aguda

R440-034130-200

R440-028130-200



gerade / straight / recta

Schaft gebogen / shaft curved
 vaina curva:

R440-034130-230

R440-028130-230



30°

rechts / right / derecha

links / left / izquierda

R440-034130-330

R440-028130-330



45°

rechts / right / derecha

links / left / izquierda

R440-034130-245

R440-028130-245

R440-034130-345

R440-028130-345



7°

aufwärts / upwards
 hacia arriba

abwärts / downwards
 hacia abajo

R440-034130-207

R440-028130-207

R440-034130-307

R440-028130-307



15°

aufwärts / upwards
 hacia arriba

abwärts / downwards
 hacia abajo

R440-034130-215

R440-028130-215

R440-034130-315

R440-028130-315



Hakenstanze, stumpf
 Hook punch, blunt nose
 Pinza cortante, de nariz roma

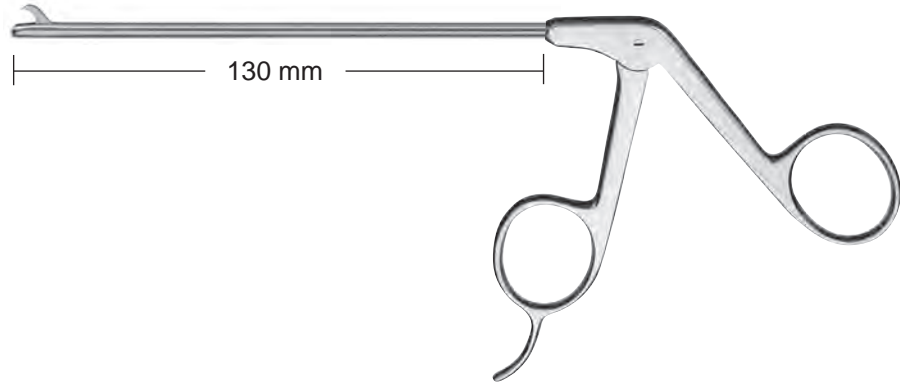

Hakenstanze, stumpf
 Hook punch, blunt nose
 Pinza cortante, de nariz roma

gerade / straight / recta

3,4 mm Ø
 cutting size 5 x 1,6

2,8 mm Ø
 cutting size 4 x 1,2

R441-034130-000

R441-028130-000



30°

Schaft gebogen / shaft curved
 vaina curva:

rechts / right / derecha

links / left / izquierda

R441-034130-030

R441-028130-030

R441-034130-130

R441-028130-130



45°

rechts / right / derecha

links / left / izquierda

R441-034130-045

R441-028130-045

R441-034130-145

R441-028130-145



7°

aufwärts / upwards
 hacia arriba

abwärts / downwards
 hacia abajo

R441-034130-007

R441-028130-007

R441-034130-107

R441-028130-107



15°

aufwärts / upwards
 hacia arriba

abwärts / downwards
 hacia abajo

R441-034130-015

R441-028130-015

R441-034130-115

R441-028130-115

Hakenstanze, stumpf 15°
 Hook punch, blunt nose 15°
 Pinza cortante, de nariz roma 15°

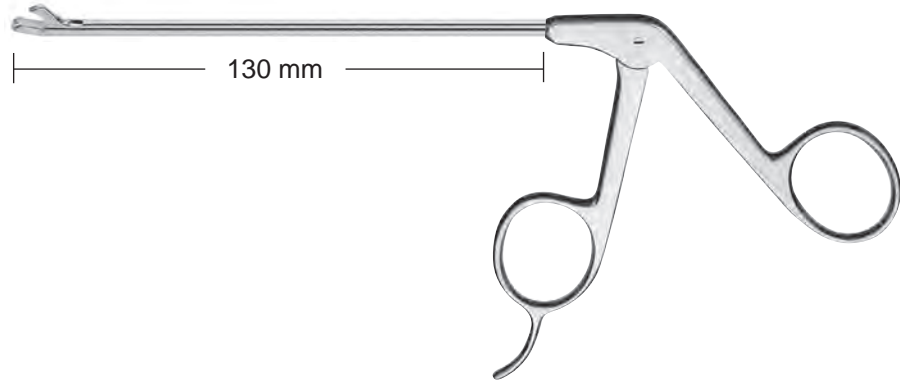

3,4 mm Ø
 cutting size 5 x 1,6

2,8 mm Ø
 cutting size 4 x 1,2

Hakenstanze, stumpf
 Hook punch, blunt nose
 Pinza cortante, de nariz roma

R441-034130-400

R441-028130-400



gerade / straight / recta

Schaft gebogen / shaft curved
 vaina curva:

R441-034130-430

R441-028130-430



30°

rechts / right / derecha

R441-034130-630

R441-028130-630



links / left / izquierda



45°

rechts / right / derecha

R441-034130-445

R441-028130-445



links / left / izquierda

R441-034130-645

R441-028130-645



7°

aufwärts / upwards
 hacia arriba

R441-034130-407

R441-028130-407



abwärts / downwards
 hacia abajo

R441-034130-607

R441-028130-607



15°

aufwärts / upwards
 hacia arriba

R441-034130-415

R441-028130-415



abwärts / downwards
 hacia abajo

R441-034130-615

R441-028130-615

Stanze, gezahnt, slim
 Punch, serrated, slim
 Pinza cortante aserrada, slim

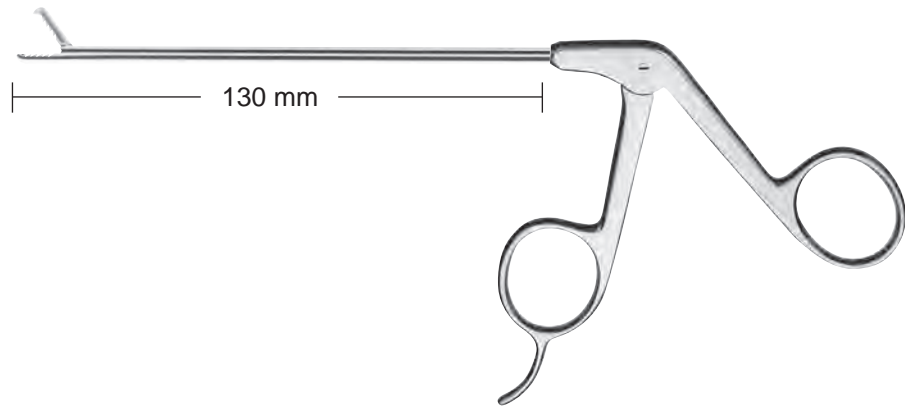

Stanze, gezahnt
 Punch, serrated
 Pinza cortante aserrada

gerade / straight / recta

3,4 mm Ø
 cutting size 6 x 2

2,8 mm Ø
 cutting size 5 x 1,6

R442-034130-000

R442-028130-000



30°

Schaft gebogen / shaft curved
 vaina curva:

rechts / right / derecha

links / left / izquierda

R442-034130-030

R442-028130-030

R442-034130-130

R442-028130-130



45°

rechts / right / derecha

links / left / izquierda

R442-034130-045

R442-028130-045

R442-034130-145

R442-028130-145



7°

aufwärts / upwards
 hacia arriba

R442-034130-007

R442-028130-007



abwärts / downwards
 hacia abajo

R442-034130-107

R442-028130-107



15°

aufwärts / upwards
 hacia arriba

R442-034130-015

R442-028130-015











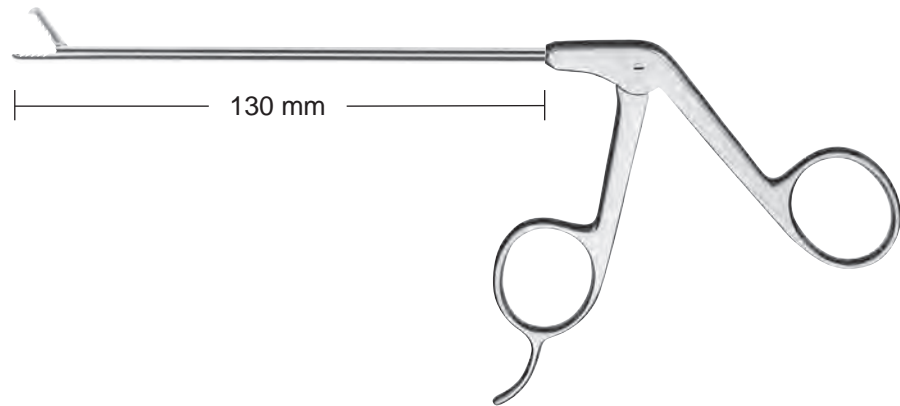

abwärts / downwards
 hacia abajo

R442-034130-115

R442-028130-115

Stanze, gezahnt „Duck“ Form
 Punch, serrated, „Duck“ shaped
 Pinza cortante, aserrada, pico de pato



		3,4 mm Ø cutting size 6 x 2	2,8 mm Ø cutting size 5 x 1,6
	Stanze, gezahnt „Duck“ Form 15° Punch, serrated, „Duck“ shaped 15° Pinza cortante, aserrada, pico de pato 15° gerade / straight / recta	R441-034130-200	R441-028130-200
	Schaft gebogen / shaft curved vaina curva:		
	rechts / right / derecha	R441-034130-230	R441-028130-230
	links / left / izquierda	R441-034130-330	R441-028130-330
	rechts / right / derecha	R441-034130-245	R441-028130-245
	links / left / izquierda	R441-034130-345	R441-028130-345
	aufwärts / upwards hacia arriba	R441-034130-207	R441-028130-207
	abwärts / downwards hacia abajo	R441-034130-307	R441-028130-307
	aufwärts / upwards hacia arriba	R441-034130-215	R441-028130-215
	abwärts / downwards hacia abajo	R441-034130-315	R441-028130-315

Stanze, gezahnt, lang
 Punch, serrated, long
 Pinza cortante, larga

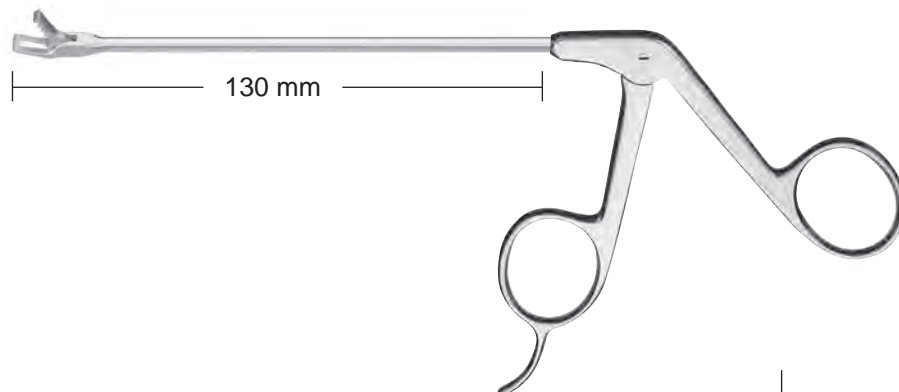

Standard



Duck

gerade / straight / recta

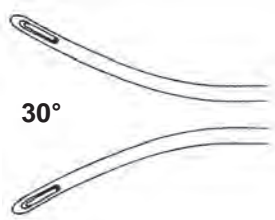

30°

Schaft gebogen / shaft curved
 vaina curva:

rechts / right / derecha

links / left / izquierda

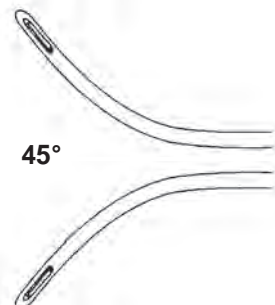

45°

rechts / right / derecha

links / left / izquierda

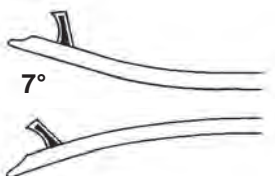

7°

aufwärts / upwards
 hacia arriba



abwärts / downwards
 hacia abajo

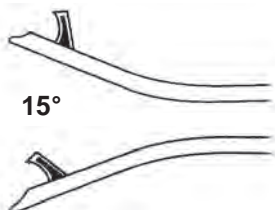

15°

aufwärts / upwards
 hacia arriba



abwärts / downwards
 hacia abajo

Standard

Duck“ Form, 15°
 Duck“ shaped, 15°
 pico de pato, 15°

3,4 mm Ø
 cutting size 6 x 3,5

3,4 mm Ø
 cutting size 6 x 3,5

R444-034130-000

R444-034130-200

R444-034130-030

R444-034130-230

R444-034130-130

R444-034130-330

R444-034130-045

R444-034130-245

R444-034130-145

R444-034130-345

R444-034130-007

R444-034130-207

R444-034130-107

R444-034130-307

R444-034130-015

R444-034130-215

R444-034130-115

R444-034130-315

Stanze, gezahnt, breit
 Punch, serrated, wide
 Pinza cortante, aserrada, ancha

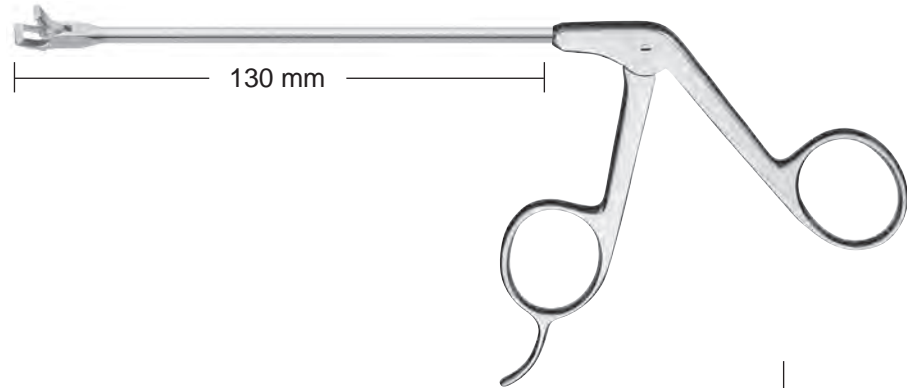

Standard

Duck“ Form, 15°
 Duck“ shaped, 15°
 pico de pato, 15°

3,4 mm Ø
 cutting size 4 x 4

3,4 mm Ø
 cutting size 4 x 4

R443-034130-000

R443-034130-200



Standard



Duck

gerade / straight / recta

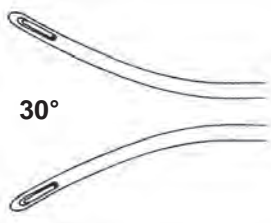

30°

Schaft gebogen / shaft curved
 vaina curva:

rechts / right / derecha

links / left / izquierda

R443-034130-030

R443-034130-230

R443-034130-130

R443-034130-330

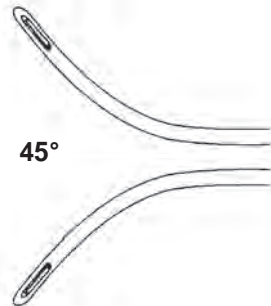

45°

rechts / right / derecha

links / left / izquierda

R443-034130-045

R443-034130-245

R443-034130-145

R443-034130-345

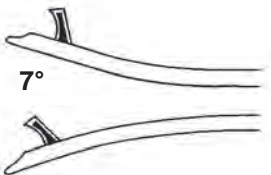

7°

aufwärts / upwards
 hacia arriba

abwärts / downwards
 hacia abajo

R443-034130-007

R443-034130-207

R443-034130-107

R443-034130-307

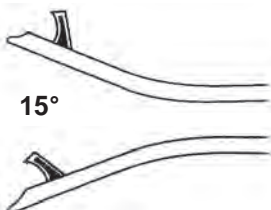

15°

aufwärts / upwards
 hacia arriba

abwärts / downwards
 hacia abajo

R443-034130-015

R443-034130-215

R443-034130-115

R443-034130-315

Stanze, gezahnt, extra breit
 Punch, serrated, extra wide
 Pinza cortante, aserrada, extra ancha

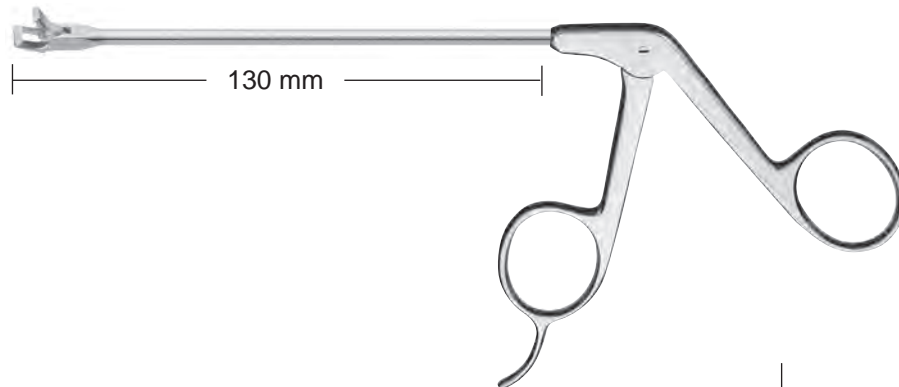

Standard



Duck

gerade / straight / recta

Standard

Duck“ Form, 15°
 Duck“ shaped, 15°
 pico de pato, 15°

3,4 mm Ø
 cutting size 5 x 4,5

3,4 mm Ø
 cutting size 5 x 4,5

R446-034130-000

R446-034130-200



30°

Schaft gebogen / shaft curved
 vaina curva:

rechts / right / derecha

links / left / izquierda

R446-034130-030

R446-034130-230

R446-034130-130

R446-034130-330



45°

rechts / right / derecha

links / left / izquierda

R446-034130-045

R446-034130-245

R446-034130-145

R446-034130-345



7°

aufwärts / upwards
 hacia arriba

abwärts / downwards
 hacia abajo

R446-034130-007

R446-034130-207

R446-034130-107

R446-034130-307



15°

aufwärts / upwards
 hacia arriba

abwärts / downwards
 hacia abajo

R446-034130-015

R446-034130-215

R446-034130-115

R446-034130-315

Mikro-Stanze
Slender Punch
Micro pinza cortante

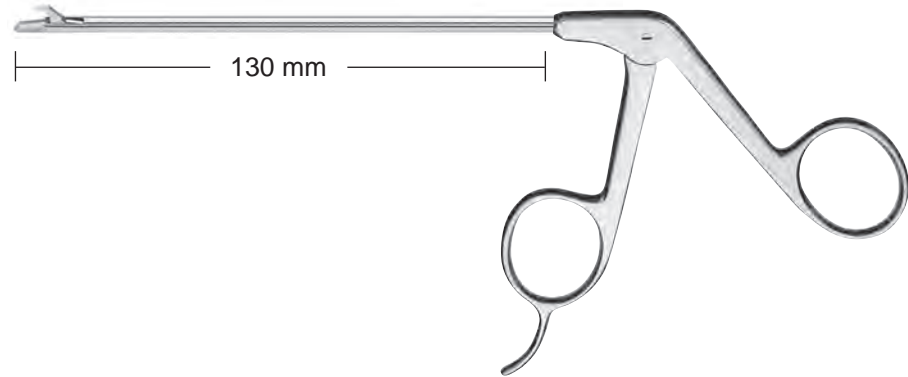

3,4 mm Ø
cutting size 0,8 x 5.5 mm



gerade / straight / recta

R447-034130-000



30°

Schaft gebogen / shaft curved
vaina curva:

rechts / right / derecha

R447-034130-030

links / left / izquierda

R447-034130-130



45°

rechts / right / derecha

R447-034130-045

links / left / izquierda

R447-034130-145



7°

aufwärts / upwards
hacia arriba

R447-034130-007



abwärts / downwards
hacia abajo

R447-034130-107



15°

aufwärts / upwards
hacia arriba

R447-034130-015



abwärts / downwards
hacia abajo

R447-034130-115

Stanze oval
 Oval Punch
 Pinza ovalada

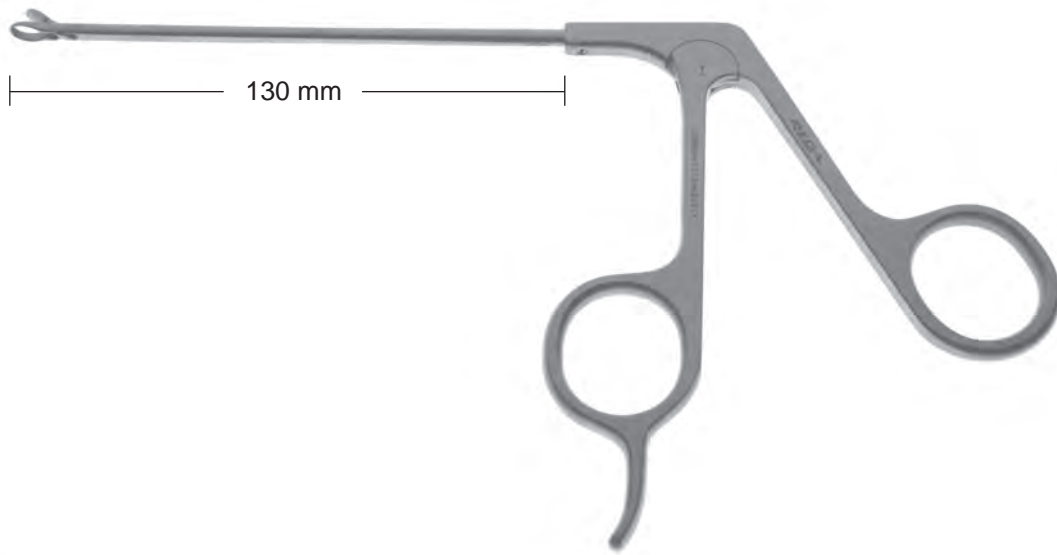

gerade / straight / recta

3,4 mm Ø
 cutting size 4,4 mm

R448-034130-000

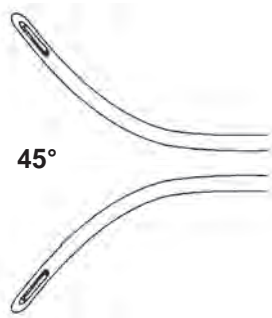

45°

rechts / right / derecha

R448-034130-045

links / left / izquierda

R448-034130-145



15°

aufwärts / upwards / hacia arriba

R448-034130-015

aufgewinkelt / angled up / angulada hacia arriba

R448-034130-200

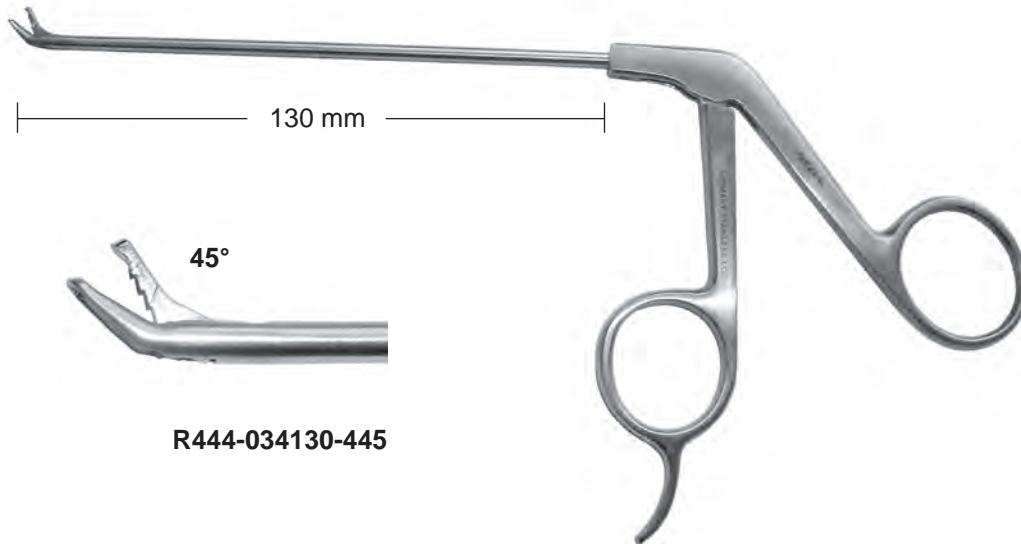

Biopsie-Stanze, 45° nach oben schneidend, 3,4 mm Ø
Biopsy punch, 45° upcurved cutting, 3.4 mm Ø
Pinza para biopsia, 45° corte hacia arriba, 3,4 mm Ø



cutting size 3,8 x 2,4

Antrumstanze durchschneidend, 3,5 mm Ø, 130 mm Nutzlänge
Antrum punch through cutting, 3.5 mm Ø, 130 mm working length
Pinza Antrum cortante, 3,5 mm Ø, largo útil de 130 mm

rechts / right / derecha



R448-035130-600

links / left / izquierda

R448-035130-800

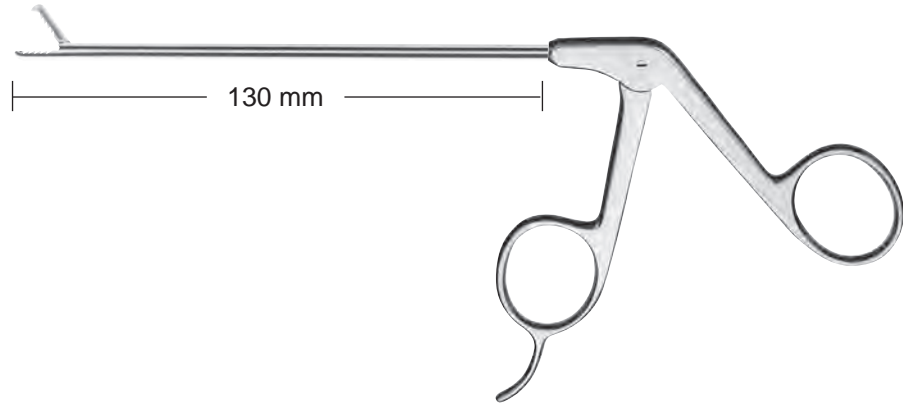
Biopsie-Stanze, seitlich schneidend 3,4 mm Ø
 Biopsy punch, side-biter 3.4 mm Ø
 Pinza para biopsia, corte lateral 3,4 mm Ø



		mit Schippe scoope nose de nariz aguda	stumpf blunt nose de nariz roma
Maulteil gewinkelt / jaw angled / boca angulada:			
 90° cutting size 5 x 1.6 mm	rechts / right / derecha	R440-034130-590	R441-034130-590
	links / left / izquierda	R440-034130-790	R441-034130-790
 45° cutting size 3,5 x 1.6 mm	rechts / right / derecha	R440-034130-545	R441-034130-545
	links / left / izquierda	R440-034130-745	R441-034130-745

Biopsie-Stanze, seitlich schneidend, breit
 Biopsy punch, side-biter, wide
 Pinza para biopsia, corte lateral, ancha

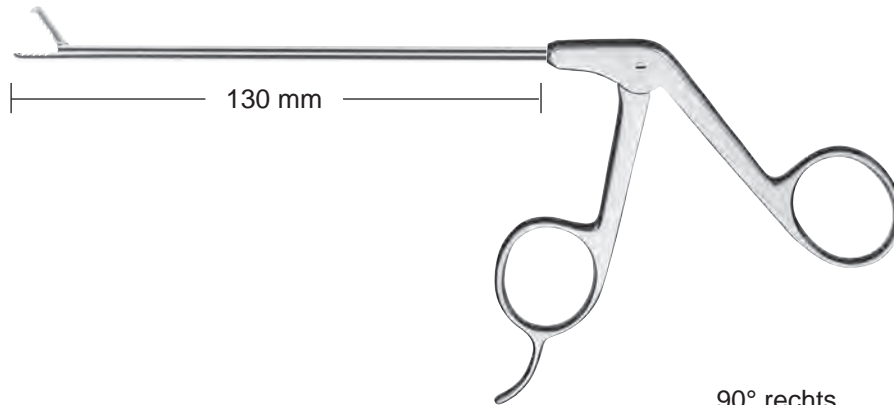

gerade / straight / recta

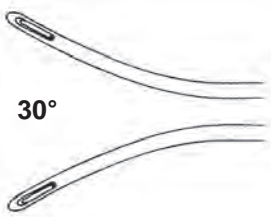

30°

Schaft gebogen / shaft curved
 vaina curva:

rechts / right / derecha

links / left / izquierda

90° rechts
 90° right
 90° derecha

90° links
 90° left
 90° izquierda

3,4 mm Ø
 cutting size 4 x 4

3,4 mm Ø
 cutting size 4 x 4

R443-034130-590

R443-034130-790

R443-034130-530

R443-034130-730

R443-034130-630

R443-034130-830

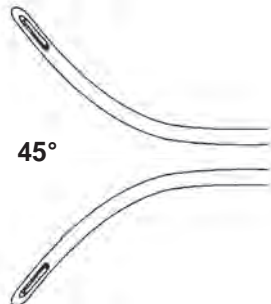

45°

rechts / right / derecha

links / left / izquierda

R443-034130-545

R443-034130-745

R443-034130-645

R443-034130-845

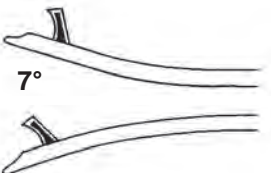

7°

aufwärts / upwards
 hacia arriba

abwärts / downwards
 hacia abajo

R443-034130-507

R443-034130-707

R443-034130-607

R443-034130-807

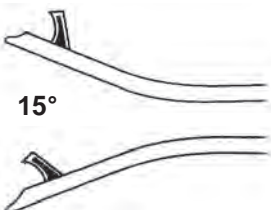

15°

aufwärts / upwards
 hacia arriba

abwärts / downwards
 hacia abajo

R443-034130-515

R443-034130-715

R443-034130-615

R443-034130-815

Rotationszange, Schnittbreite 3,4 mm
Rotary punch, cutting size 3,4 mm
Pinza rotatoria, corte de 3,4 mm



Rotationszange für große Schnitte
100 mm Nutzlänge, Zigarrengriff

Rotary punch for big cutting size
100 mm working length, cigar handle

Pinza rotatoria, para cortes grandes,
largo útil de 100 mm, mango forma cigarro



90° rechts / right
90° hacia la derecha

R449-035100-090 C



90° links / left
90° hacia la izquierda

R449-035100-190 C

Rotationszange, Schnittbreite 3,4 mm
Rotary punch, cutting size 3,4 mm
Pinza rotatoria, corte de 3,4 mm



Rotationszange für große Schnitte
100 mm Nutzlänge, Ringgriff Standard

Rotary punch for big cutting size
100 mm working length, grip handle

Pinza rotatoria, para cortes grandes,
largo útil de 100 mm, mango de anillo



90° rechts / right
90° hacia la derecha

R449-035100-090



90° links / left
90° hacia la izquierda

R449-035100-190

Saugstanze drehbar 360°
Suction punch rotatable 360°
Pinza de succión, girable en 360°

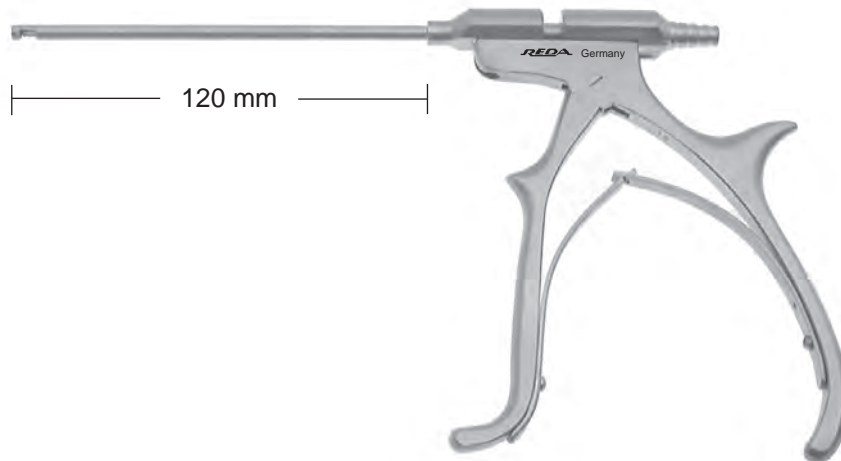

Saugstanze drehbar 360°
zerlegbar, 120 mm Nutzlänge, 4,5 mm Ø

R446-045130-00 R

Suction punch rotatable 360°
dismountable, 120 mm working length 4.5 mm Ø

Pinza de succión, girable en 360°
desmontable, largo útil de 120 mm, 4,5 mm Ø

Schneidehülse allein für Saugstanze
Cutting sleeve only for suction punch
Tubo cortante suelto para la pinza arriba mencionada



R446-045130-00 I

Mantelrohr allein
Outer tube alone
Tubo exterior

R446-045130-00 A

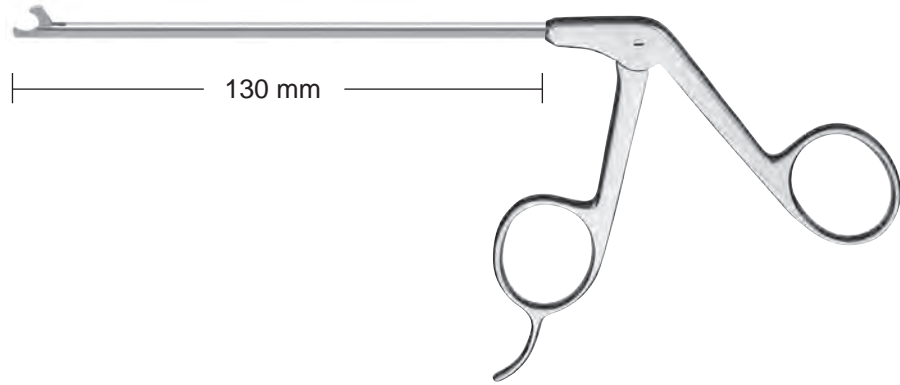
Hakenschere
Hook scissors
Tijera en forma de gancho

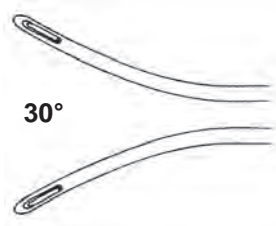
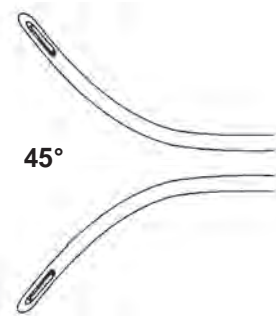

		3,4 mm Ø	2,8 mm Ø
	Hakenschere Hook scissors Tijera en forma de gancho gerade / straight / recta	R450-034130-000	R450-028130-000
	Schaft gebogen / shaft curved vaina curva: rechts / right / derecha links / left / izquierda	R450-034130-030 R450-034130-130	R450-028130-030 R450-028130-130
	rechts / right / derecha links / left / izquierda	R450-034130-045 R450-034130-145	R450-028130-045 R450-028130-145
	Maulteil gewinkelt / jaw angled boca angulada: rechts / right / derecha links / left / izquierda	R450-034130-245 R450-034130-345	

Schere gezahnt
Scissors serrated
Tijera dentada

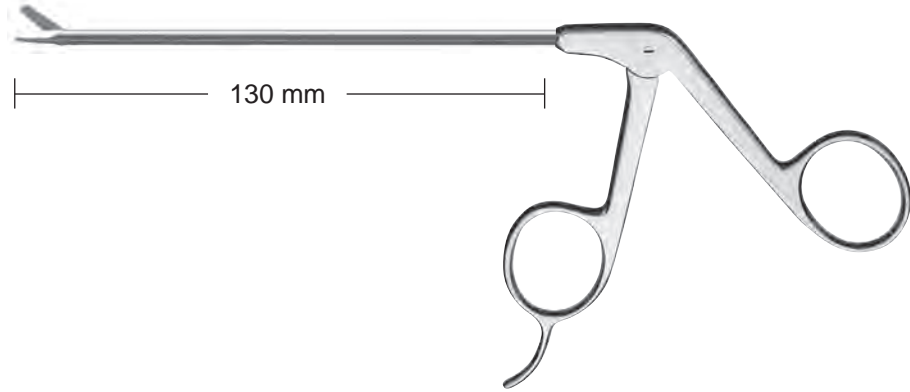

3,4 mm Ø



Schere gezahnt
Scissors serrated
Tijera dentada
gerade / straight / recta

R451-034130-000

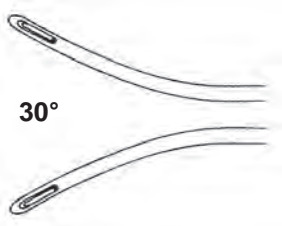

Schaft gebogen / shaft curved
vaina curva:
rechts / right / derecha
links / left / izquierda

R451-034130-030

R451-034130-130

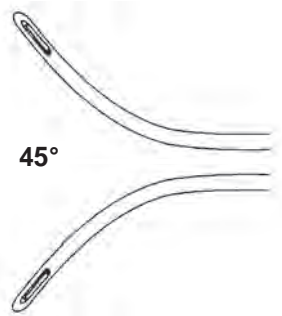

rechts / right / derecha
links / left / izquierda

R451-034130-045

R451-034130-145

Faßzangen
Grasper
Pinzas de agarre

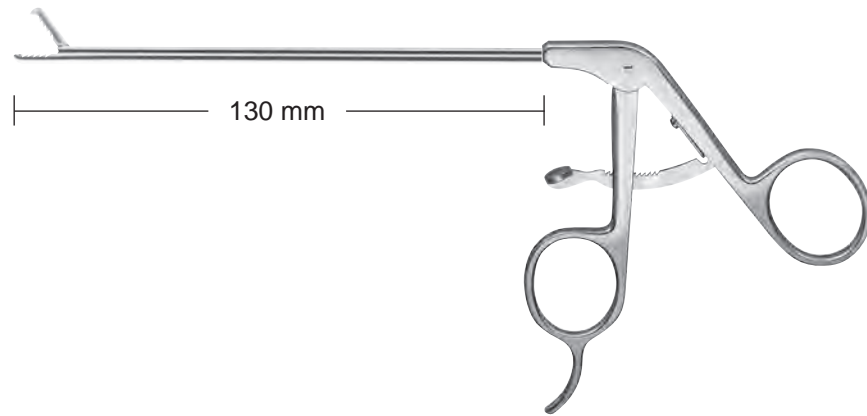

Greifzange
Alligator grasping Forceps
Pinza de agarre

3,4 mm Ø **R430-034130-000**
2,8 mm Ø **R430-028130-000**

Greifzange mit Sperre
Alligator grasping forceps, with ratchet
Pinza de agarre con cremallera

3,4 mm Ø **R431-034130-000**
2,8 mm Ø **R431-028130-000**



Faßzange mit Mauszahn
Alligator grasping forceps with mouse teeth
Pinza de agarre con diente de ratón

3,4 mm Ø **R432-034130-000**
2,8 mm Ø **R432-028130-000**

Faßzange, Mauszahn und Sperre
Alligator grasping forceps with mouse teeth and ratchet
Pinza de agarre con diente de ratón y cremallera

3,4 mm Ø **R433-034130-000**
2,8 mm Ø **R433-028130-000**



Faß-Biopsie-Zange
Grasping and biopsy forceps
Pinza de agarre y biopsia

3,4 mm Ø **R434-034130-000**
2,8 mm Ø **R434-028130-000**

Faß-Biopsie-Zange mit Sperre
Grasping and biopsy forceps with ratchet
Pinza de agarre y biopsia con cremallera

3,4 mm Ø **R435-034130-000**
2,8 mm Ø **R435-028130-000**

Biopsie-Zange
Biopsy forceps
Pinza de biopsia

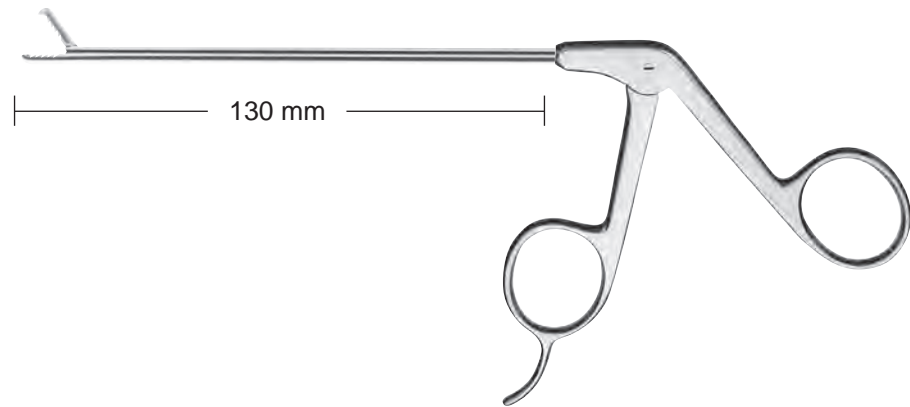

Biopsiezange
Biopsy forceps
Pinza de biopsia

3,4 mm Ø **R436-034130-000**
2,8 mm Ø **R436-028130-000**



Biopsiezange, mit Dorn
Biopsy forceps, with spike
Pinza de biopsia, con espina

3,4 mm Ø **R436-034130-001**
2,8 mm Ø **R436-028130-001**

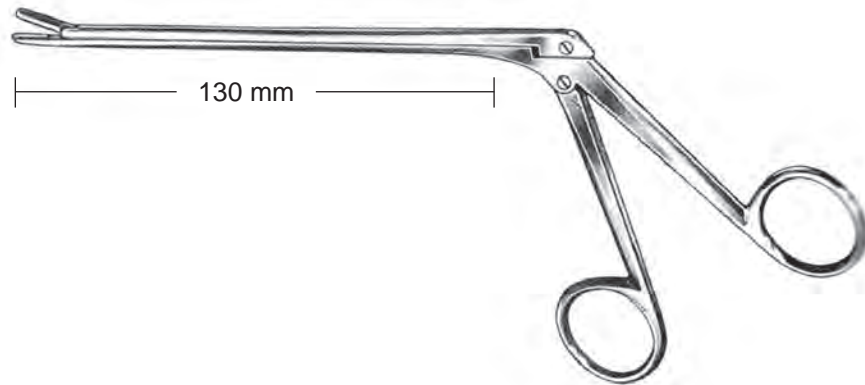

Meniskus-Faßzange kräftig
Meniscus grasping forceps, strong
Pinza de agarre para el menisco, fuerte

2 x 10 mm **R436-042150-210**
3 x 10 mm **R436-042150-310**
4 x 10 mm **R436-042150-410**

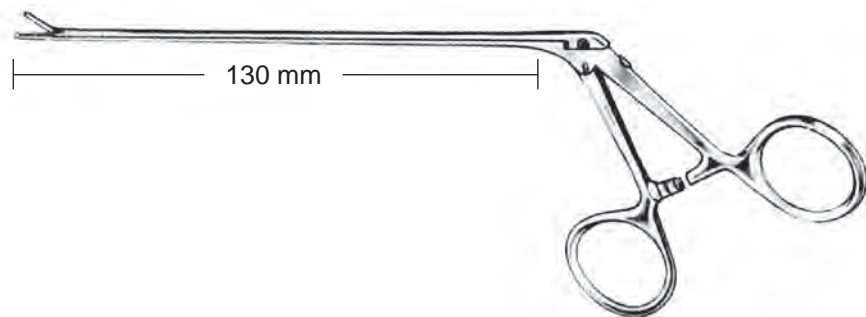

Mini-Faß-Zange mit Mauszahn und Sperre, 2,2 mm Ø
Mini grasper with mouse teeth and ratchet, 2.2 mm Ø
Pinza de agarre, modelo mini, con diente de ratón y cremallera, 2,2 mm Ø

R437-022130-000

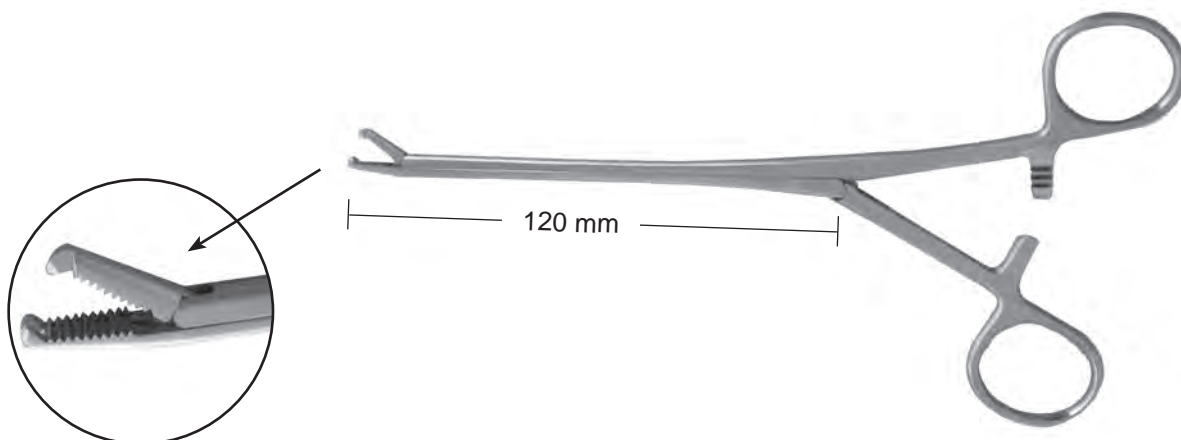

Meniskusretraktor gerade mit Mauszahn und Sperre
Meniscus retractor straight with mouse teeth and ratchet
Retractor de menisco, recto, con diente de ratón y cremallera

R438-035130-000

Fadenzangen, ø 3,4 mm
 Ligature forceps, ø 3,4 mm
 Pinzas para ligadura, ø 3,4 mm

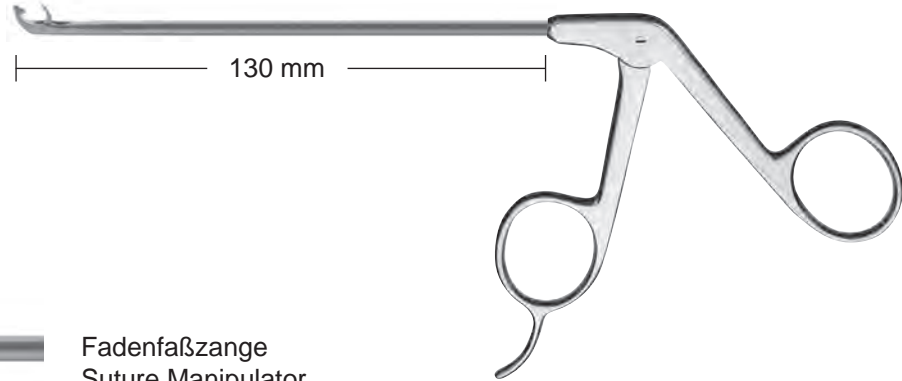

Fadenfaßzange
 Suture Manipulator
 pinza de agarre para sutura



gerade / straight / recta

R439-034130-000

15°

aufwärts / upwards
 hacia arriba

R439-034130-015

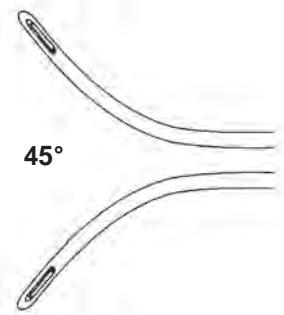

45°

rechts / right / derecha

R439-034130-045

links / left / izquierda

R439-034130-145



Fadenfänger gerade
 Suture grasper
 pinza de agarre recta

R439-034130-100



15°

aufwärts / upwards
 hacia arriba

R439-034130-115



Faden Punch gerade
 Suture punch straight
 pinza de agarre recta

R439-034130-200



45° aufwärts / upwards
 45° hacia arriba

R439-034130-300



10° aufwärts / upwards
 10° hacia arriba

R439-034130-310



Hakensonde graduiert
Hook probe graduated
Gancho explorador graduado
3 mm
5 mm

R490-030110-03
R490-030110-05



Skalpellmesser
Scalpel knife
Cuchillo de bisturí

R490-030110-11



Hakenmesser
Hook knife
Cuchillo en forma de gancho

R490-030110-12



Messer retrograd
Knife, retrograde
Cuchillo retrógrado

R490-030110-13

Banana-Messer
Banana knife
Cuchillo en forma de plátano



glatt / smooth / liso

R490-030110-14



gezahnt / serrated / dentado

R490-030110-15



Rosettenmesser
Rosette knife
Cuchillo en forma de roseta

R490-030110-16



Meniskotom nach Smillie
Smillie knife
Meniscótomo de Smillie

3 mm

R490-030110-43

5 mm

R490-030110-45

7 mm

R490-030110-47

Messer sichelförmig
Sickle knife
Cuchillo en forma de hoz

R490-030110-17

Löffel, 3 mm Ø
Spoon, 3 mm Ø
Cucharilla, 3 mm Ø

R490-030110-21

Ring-Kürette
Ring curette
Cureta en forma de anillo

3 mm Ø

R490-030110-31

5 mm Ø

R490-030110-32

7 mm Ø

R490-030110-33

Knorpelfeile, fein
Cartilage file, fine
Lima para cartilago, fina

R490-030110-51

Knorpelfeile, grob
Cartilage file, coarse
Lima para cartilago, gruesa

R490-030110-52



Griff allein mit Spannzange
 Handle alone with wrench
 Mango solo con adaptador de fijación

R492-000000-000



Meniskotom nach Smillie
 Smillie knife
 Meniscótomo de Smillie

3 mm
 5 mm
 7 mm

R492-030110-43
R492-030110-45
R492-030110-47



Messer sichelförmig
 Sickle knife
 Cuchillo en forma de hoz

R492-030110-17



Löffel, 3 mm Ø
 Spoon, 3 mm Ø
 Cucharilla, 3 mm Ø

R492-030110-21



Ring-Kürette, 3 mm Ø
 Ring curette, 3 mm Ø
 Cureta en forma de anillo, 3 mm Ø

R492-030110-31



Ring-Kürette, 7 mm Ø
 Ring curette, 7 mm Ø
 Cureta en forma de anillo, 7 mm Ø

R492-030110-32



Knorpelfeile, fein
 Cartilage file, fine
 Lima para cartilago, fina

R492-030110-51



Knorpelfeile, grob
 Cartilage file, coarse
 Lima para cartilago, gruesa

R492-030110-52

Hand-Instrumente, zweiteilig
Hand instruments, two parts
Instrumentos manuales, de dos partes



Hakensonde graduiert
Hook probe graduated
Gancho explorador graduado

2,5 mm
3,5 mm

R492-030110-03
R492-030110-04

Hakensonde spitz
Palpation hook pointed
Gancho explorador agudo

R492-030110-00



Skalpellmesser
Scalpel knife
Cuchillo de bisturí

R492-030110-11



Hakenmesser
Hook knife
Cuchillo en forma de gancho

R492-030110-12



Messer retrograd
Knife retrograde
Cuchillo retrógrado

R492-030110-13

Banana-Messer
Banana knife
Cuchillo en forma de plátano



glatt / smooth / liso

R492-030110-14



gezahnt / serrated / dentado

R492-030110-15



Rosettenmesser
Rosette knife
Cuchillo en forma de roseta

R492-030110-16



Meniskotom nach Smillie
Smillie meniscotome
Meniscótomo de Smillie

3 mm
5 mm

R494-030110-43
R494-030110-45



Messer sichelförmig
Sickel knife
Cuchillo en forma de hoz

R494-030110-17



Löffel, 3 mm Ø
Spoon 3 mm Ø
Cucharilla, 3 mm Ø

R494-030110-21



Ring-Kürette, 3 mm Ø
Ring curette, 3 mm Ø
Cureta en forma de anillo, 3 mm Ø

R494-030110-31

Hakensonde
Hook probe
Gancho explorador3,5 mm graduiert / graduated / graduado
4 mm**R494-030110-03**
R494-030110-04Skalpelmesser
Scalpel knife
Cuchillo de bisturí**R494-030110-11**Hakenmesser
Hook knife
Cuchillo en forma de gancho**R494-030110-12**Messer retrograd
Knife, retrograde
Cuchillo retrógrado**R494-030110-13**Banana-Messer
Banana knife
Cuchillo en forma de plátano

glatt / smooth / liso

R494-030110-14

gezahnt / serrated / dentado

R494-030110-15Rosettenmesser
Rosette knife
Cuchillo en forma de roseta**R494-030110-16**Knorpelfeile, fein
Cartilage file, fine
Lima para cartilago, fina**R494-030110-51**Knorpelfeile, grob
Cartilage file, coarse
Lima para cartilago, gruesa**R494-030110-52**



Spülkanüle mit 2 seitlichen Löchern, LL-Anschluß, 4,5 mm Ø, 8,3 cm
Irrigation cannula with 2 holes, LL-connection, 4.5 mm Ø, 8.3 cm
Canula de irrigación con dos perforaciones laterales, conexión LL, 4,5 mm Ø, 8,3 cm

R470-045083-000



scharfer Obturator
sharp obturator
obturador agudo

R470-045083-001



stumpfer Obturator
blunt obturator
obturador romo

R470-045083-002



Spüladapter mit Schlaucholive
Irrigation adapter with tube connection
Adaptador con conexión al tubo

R470-045000-000

Spülkanüle
Irrigation cannula
Cánula de irrigación

Spülsatz, komplett mit Kanüle und Obturatoren
Aspiration cannula complete with canula and obturators
Canula de irrigación completa con canula e obturadores

3,2 mm Ø

4,5 mm Ø

R471-032070-199**R471-045070-199**

Kanüle für Spülung mit Hahn, LL-Anschluß, 7 cm lang
Cannula for irrigation with stop cock LL-connection, 7 cm length
Cánula de irrigación con llave, conexión LL, largo útil de 7 cm

R471-032070-000**R471-045070-000**

scharfer Obturator
sharp obturator
obturador agudo

R471-032070-024**R471-045070-024**

stumpfer Obturator
blunt obturator
obturador romo

R471-032070-003**R471-045070-003**

Kanüle für Spülung, LL-Anschluß, 3,2 mm Ø, 7 cm lang
Cannula for irrigation, LL-connection, 3,2 mm Ø, 7 cm length
Cánula de irrigación, conexión LL, 3,2 mm Ø, largo útil de 7 cm

R472-032070-000

Ø 1,9 mm

Arthroskop, autoklavierbar mit integrierter Faser zur Beleuchtung für diagnostische und operative Eingriffe:
kleine Gelenke

Arthroscope, autoclavable, with integrated fiber optic for illumination, for diagnostic and operation:
small joint

Artroscopios (ópticas) autoclavables con fibraoptica incorporado para intervenciones diagnósticas y operativas:
articulaciones pequeñas

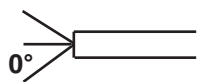

Geradeausblick
Direct vision
Vision directa

69 mm

R400-019069-000

102 mm

R400-019102-000

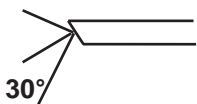

Vorausblick
Foroblique vision
ángulo de

R400-019069-030

R400-019102-030

Trokarhülsen für Endoskope mit Ø 1,9 mm
Trocar sleeves for endoscopes with Ø 1.9 mm
Tubos para endoscopios de Ø 1,9 mm

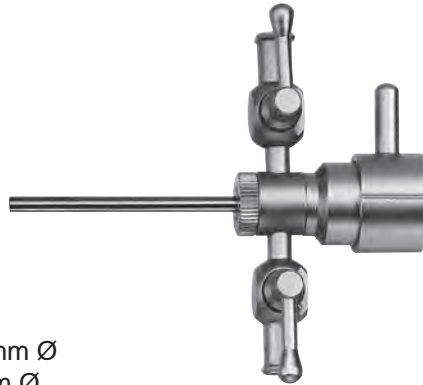

Trokar-Hülse mit zwei Spülhähnen, drehbar, 1,9 mm Ø
Trocar sleeve, with two stop cocks rotating, 1.9mm Ø
Tubo con dos llaves giratorias, de 1,9 mm Ø

	0°	30°
69 mm	R414-019069-000	R414-019069-030
102 mm	R414-019102-000	R414-019102-030

Obturator 1,9 mm Ø
Obturator 1.9 mm Ø
Obturador de 1,9 mm Ø

scharf / sharp / agudo



69 mm	R410-019069-001
102 mm	R410-019102-001

konisch stumpf / conical blunt / cónico romo



69 mm	R410-019069-002
102 mm	R410-019102-002

stumpf / blunt / romo



69 mm	R410-019069-003
102 mm	R410-019102-003



Trokarhülse mit scharfem und stumpfem Obturator, 2,5 mm Ø
Trocar sleeve with sharp and blunt obturator, 2.5 mm Ø
Tubo con obturadores agudos y romos, 2,5 mm Ø

R490-025110-43

Instrumente für 2. Einstich
Instruments for 2nd puncture
Instrumentos para la segunda perforación

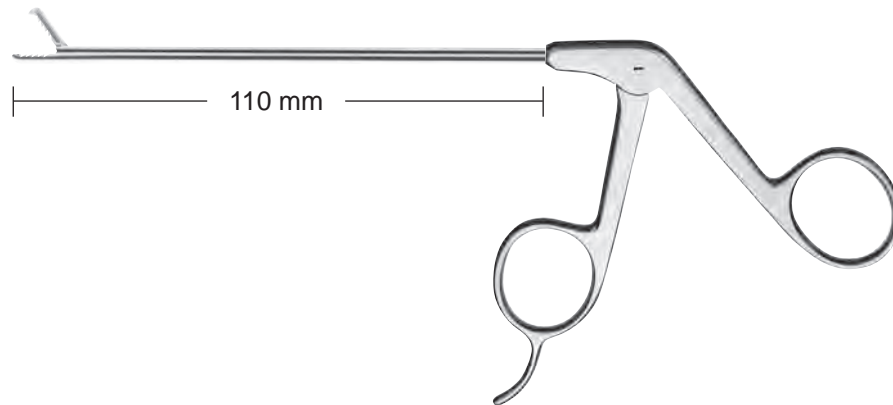

Zange mit Doppellöfel, 2 mm Ø
Forceps with double spoon, 2 mm Ø
Pinza con cucharilla doble, 2 mm Ø

R480-020110-000



Zange durchschneidend, 2 mm Ø
Forceps cutting through, 2 mm Ø
Pinza cortante, 2 mm Ø

R481-020110-000



Schere, 2 mm Ø
Scissors, 2 mm Ø
Tijera, 2 mm Ø

R485-020110-000



Faß-Biopsie-Zange, 2 mm Ø
Grasping and biopsy forceps, 2 mm Ø
Pinza de agarre y biopsia, 2 mm Ø

R486-020110-000



Greif-Zange, 2 mm Ø
Grasping Forceps, 2 mm Ø
Pinza de agarre, 2 mm Ø

R487-020110-000

Farbcode für Blickrichtung:
Colour coding for indication of direction of view:
Indicación a color para definir la dirección de la vista:

grün / green / verde	= 0°
rot / red / rojo	= 30°
orange / orange / naranja	= 45°
gelb / yellow / amarillo	= 70°

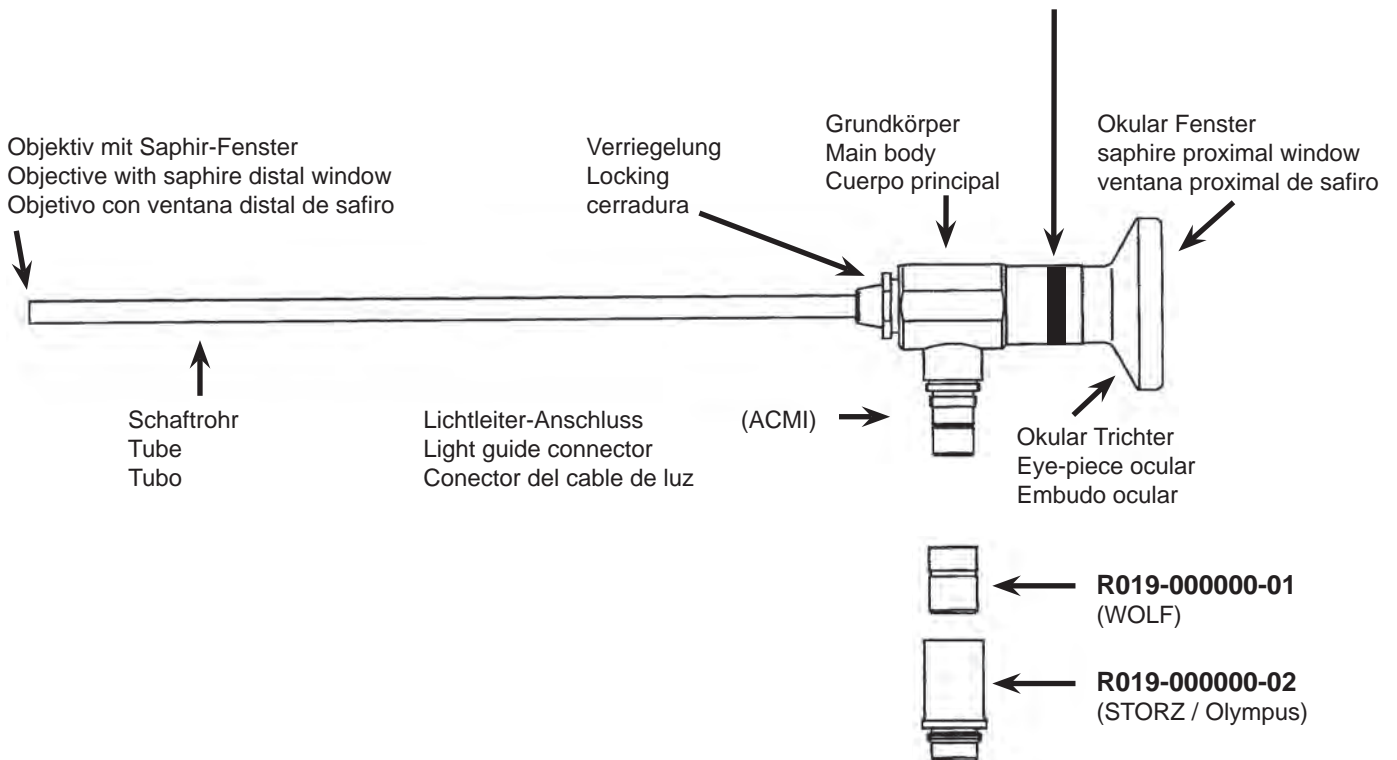

Scope Pak klein für Arthroskop
Scope pak small for one Arthroscope
Caja pequeña para Artroscofio

R019-9312

Zubehör
Accessories
Accesorios



Antieschlagmittel Ultra Stop 25 ml unsteril in Pipettenflasche
Anti Fog liquid Ultra Stop 25 ml non sterile
Agente antivano ultra stop 25 ml, no esteril en frasco de pipeta

R019-000000-025

Antieschlagmittel Ultra Stop steril 30 ml in Einstichflasche
Anti Fog liquid Ultra Stop sterile incision bottle 30 ml
Agente antivano ultra stop, esteril 30 ml en frasco de pinchazo

R019-000000-030



Reinigungsmittel, Tube mit 6gr. f. distale u. proximale Linsen u. Fiberglas-Flächen von Endoskopen
Cleaning waste, 6gr. f. distal and proximal windows and fiber optic port of endoscopes
Agente de limpieza, tubo con 6gr para ventanas y optical distales y proximales

98002-06

Container Typen und Dimensionen
Container models and dimensions
Modelos de contenedores y medidas

285 x 280 x 200 mm



Deckel gelocht
 Boden ungelocht
 Perforated lid
 Unperforated bottom
 Tapa perforada
 Cuerpo sin perforación



Deckel gelocht
 Boden gelocht
 Perforated lid
 Perforated bottom
 Tapa perforada
 Cuerpo perforado



Sicherheitsdeckel
 Boden ungelocht
 Safety lid
 Unperforated bottom
 Tapa de seguridad
 Cuerpo sin perforación



Sicherheitsdeckel
 Boden gelocht
 Safety lid
 Perforated bottom
 Tapa de seguridad
 Cuerpo perforado



silber
 gelb
 rot
 blau
 grün

R 310.20
 R 320.20
 R 330.20
 R 340.20
 R 350.20

R 311.20
 R 321.20
 R 331.20
 R 341.20
 R 351.20

R 312.20
 R 322.20
 R 332.20
 R 342.20
 R 352.20

R 313.20
 R 323.20
 R 333.20
 R 343.20
 R 353.20

Lagerungs- und Sterilisierack
Storage- and sterilization rack
Soporto para almacenaje y esterilizacion

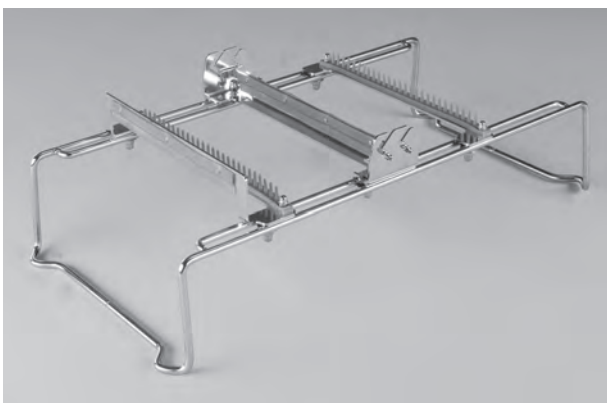

89258-25
 232 x 210 x 155 mm

für Arthroskopie Instrumente
 for arthroscopy instruments
 para instrumentos de atroscopia

Mindestabnahme: 5 Stück
 Minimum purchase: 5 pieces
 Cantidad minima: 5 unidades

Orientierungsmarkierung
 Orientation marking
 Marca de orientación

Viele geometrischen Formen für
 Rotationsmesser und Fräser

Wide variety of geometric forms
 for shaver blades and burrs

Amplia variedad de formas
 geométricas para cuchillas y
 fresas rotatorias

Kompatibel mit verschiedenen
 Herstellern von Shaver Systemen

Compatible with different
 manufacturers of shaver systems

Compatible con diversos
 fabricantes de sistemas shaver

Farbcode für die Identifizierung verschiedener
 geometrischer Formen von Rotationsmessern und
 Fräsern.

Color code for identify different geometry
 forms of shaver blades and burrs

Código de color para identificar las diferentes
 formas geométricas de las cuchillas y fresas
 rotatorias

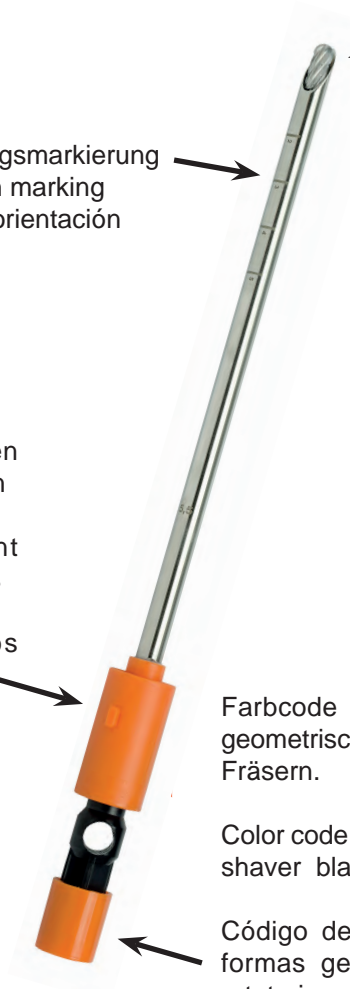

REMA,
 Linvatec,
 Arthrex,
 Concept,
 Atlantec

REMA,
 Arthrex
 APS II

Dyonics EP1
 (smith & nephew)

Dyonics
 PS3500
 EP
 (smith & nephew)
 on request

Aesculap
 on request

Stryker
 Formula

Stryker
 SE-3, SE-4,
 SE-5
 on request

Arthronet
 on request

Hinweis: die Markierung ist hilfreich für die Orientierung, nicht zum Messen.
 Note: the marking is useful for orientation, not for measure.
 Nota: el marcado solo es útil para orientación, no para medir.

Auf Anfrage auch lieferbar in single use, steril
 on request available in single use, steril
 a petición disponible en desechable y esteril

Shaver blades for Linvatec, Concept, Arthrex, Atlantec



Länge 130 mm, autoklavierbar, wiederverwendbar
 Length 130 mm, autoclavable, reusable
 Largo 130 mm, autoclavable, reusable

	Beschreibung Description Descripcion	ø 3,4 mm	ø 4,2 mm	ø 5,5 mm	
	Aggressive Full-Radius Resector	R452-034130-001	R452-042130-001	R452-055130-001	● ●
	Double Aggressive Full-Radius		R452-042130-002	R452-055130-002	○ ●
	Meniscus Cutter	R452-034130-003	R452-042130-003	R452-055130-003	● ●
	End Cutter		R452-042130-004	R452-055130-004	○ ●
	Full-Radius Resector	R452-034130-005	R452-042130-005	R452-055130-005	○ ○
	Incisor	R452-034130-006	R452-042130-006	R452-055130-006	● ●
	Cutter		R452-042130-007		● ○
	Round Burr		R452-042130-008	R452-055130-008	● ●
	Tapered Burr			R452-055130-009	● ●
	Oval Burr		R452-042130-010	R452-055130-010	● ●

Shaver blades for Arthrex APS II



Länge 130 mm, autoklavierbar, wiederverwendbar
 Length 130 mm, autoclavable, reusable
 Largo 130 mm, autoclavable, reusable

	Beschreibung Description Descripcion	ø 3,4 mm	ø 4,2 mm	ø 5,5 mm	
	Aggressive Full-Radius Resector	R453-034130-001	R453-042130-001	R453-055130-001	● ●
	Double Aggressive Full-Radius		R453-042130-002	R453-055130-002	○ ●
	Meniscus Cutter	R453-034130-003	R453-042130-003	R453-055130-003	● ●
	End Cutter		R453-042130-004	R453-055130-004	○ ●
	Full-Radius Resector	R453-034130-005	R453-042130-005	R453-055130-005	○ ○
	Incisor	R453-034130-006	R453-042130-006	R453-055130-006	● ●
	Cutter		R453-042130-007		● ○
	Round Burr		R453-042130-008	R453-055130-008	● ●
	Tapered Burr			R453-055130-009	● ●
	Oval Burr		R453-042130-010	R453-055130-010	● ●

Shaver blades for Dyonics EP-1 (smith&nephew)



Länge 130 mm, autoklavierbar, wiederverwendbar
 Length 130 mm, autoclavable, reusable
 Largo 130 mm, autoclavable, reusable

	Beschreibung Description Descripcion	ø 3,4 mm	ø 4,2 mm	ø 5,5 mm	
	Aggressive Full-Radius Resector	R454-034130-001	R454-042130-001	R454-055130-001	● ●
	Double Aggressive Full-Radius		R454-042130-002	R454-055130-002	○ ●
	Meniscus Cutter	R454-034130-003	R454-042130-003	R454-055130-003	● ●
	End Cutter		R454-042130-004	R454-055130-004	○ ●
	Full-Radius Resector	R454-034130-005	R454-042130-005	R454-055130-005	○ ○
	Incisor	R454-034130-006	R454-042130-006	R454-055130-006	● ●
	Cutter		R454-042130-007		● ○
	Round Burr		R454-042130-008	R454-055130-008	● ●
	Tapered Burr			R454-055130-009	● ●
	Oval Burr		R454-042130-010	R454-055130-010	● ●

Shaver blades for Stryker formula



Länge 130 mm, autoklavierbar, wiederverwendbar
 Length 130 mm, autoclavable, reusable
 Largo 130 mm, autoclavable, reusable

	Beschreibung Description Descripcion	ø 3,4 mm	ø 4,2 mm	ø 5,5 mm	
	Aggressive Full-Radius Resector	R455-034130-001	R455-042130-001	R455-055130-001	● ●
	Double Aggressive Full-Radius		R455-042130-002	R455-055130-002	○ ●
	Meniscus Cutter	R455-034130-003	R455-042130-003	R455-055130-003	● ●
	End Cutter		R455-042130-004	R455-055130-004	○ ●
	Full-Radius Resector	R455-034130-005	R455-042130-005	R455-055130-005	○ ○
	Incisor	R455-034130-006	R455-042130-006	R455-055130-006	● ●
	Cutter		R455-042130-007		● ○
	Round Burr		R455-042130-008	R455-055130-008	● ●
	Tapered Burr			R455-055130-009	● ●
	Oval Burr		R455-042130-010	R455-055130-010	● ●

89258-25	53	R413-027110-030	11	R440-028130-130	16
98002-06	52	R413-027110-070	11	R440-028130-145	16
R 310.20	53	R413-027175-030	13	R440-028130-200	17
R 311.20	53	R413-027175-070	13	R440-028130-207	17
R 312.20	53	R413-027188-030	15	R440-028130-215	17
R 313.20	53	R413-027188-070	15	R440-028130-230	17
R 320.20	53	R413-040106-030	7	R440-028130-245	17
R 321.20	53	R413-040106-070	7	R440-028130-307	17
R 322.20	53	R413-040120-030	8	R440-028130-315	17
R 323.20	53	R413-040120-070	8	R440-028130-330	17
R 330.20	53	R413-040136-030	6	R440-028130-345	17
R 331.20	53	R413-040136-070	6	R440-034130-000	16
R 332.20	53	R413-040175-030	5	R440-034130-007	16
R 333.20	53	R413-040175-070	5	R440-034130-015	16
R 340.20	53	R414-019069-000	48	R440-034130-030	16
R 341.20	53	R414-019069-030	48	R440-034130-045	16
R 342.20	53	R414-019102-000	48	R440-034130-107	16
R 343.20	53	R414-019102-030	48	R440-034130-115	16
R 350.20	53	R414-027110-030	11	R440-034130-130	16
R 351.20	53	R414-027110-070	11	R440-034130-145	16
R 352.20	53	R414-027175-030	13	R440-034130-200	17
R 353.20	53	R414-027175-070	13	R440-034130-207	17
R019-000000-01	51	R414-027188-030	15	R440-034130-215	17
R019-000000-02	51	R414-027188-070	15	R440-034130-230	17
R019-000000-025	52	R414-040106-030	7	R440-034130-245	17
R019-000000-030	52	R414-040106-070	7	R440-034130-307	17
R019-9312	51	R414-040120-030	8	R440-034130-315	17
R400-019069-000	47	R414-040120-070	8	R440-034130-330	17
R400-019069-030	47	R414-040136-030	6	R440-034130-345	17
R400-019069-030	47	R414-040136-070	6	R440-034130-545	28
R400-019102-000	47	R414-040175-030	5	R440-034130-590	28
R400-027110-000	10	R414-040175-070	5	R440-034130-745	28
R400-027110-030	10	R430-028130-000	35	R440-034130-790	28
R400-027110-070	10	R430-034130-000	35	R441-028130-000	18
R400-027175-000	12	R431-028130-000	35	R441-028130-007	18
R400-027175-030	12	R431-034130-000	35	R441-028130-015	18
R400-027175-070	12	R432-028130-000	35	R441-028130-030	18
R400-027188-000	14	R432-034130-000	35	R441-028130-045	18
R400-027188-030	14	R433-028130-000	35	R441-028130-107	18
R400-027188-070	14	R433-034130-000	35	R441-028130-115	18
R400-040175-000	4	R434-028130-000	35	R441-028130-130	18
R400-040175-030	4	R434-034130-000	35	R441-028130-145	18
R400-040175-045	4	R435-028130-000	35	R441-028130-200	21
R400-040175-070	4	R435-034130-000	35	R441-028130-207	21
R410-019069-001	48	R436-028130-000	36	R441-028130-215	21
R410-019069-002	48	R436-028130-001	36	R441-028130-230	21
R410-019069-003	48	R436-034130-000	36	R441-028130-245	21
R410-019102-001	48	R436-034130-001	36	R441-028130-307	21
R410-019102-002	48	R436-042150-210	37	R441-028130-315	21
R410-019102-003	48	R436-042150-310	37	R441-028130-330	21
R410-027110-001	11	R436-042150-410	37	R441-028130-345	21
R410-027110-002	11	R437-022130-000	37	R441-028130-400	19
R410-027110-003	11	R438-035130-000	37	R441-028130-407	19
R410-027175-001	13	R439-034130-000	38	R441-028130-415	19
R410-027175-002	13	R439-034130-015	38	R441-028130-430	19
R410-027175-003	13	R439-034130-045	38	R441-028130-445	19
R410-027188-001	15	R439-034130-100	38	R441-028130-607	19
R410-027188-002	15	R439-034130-115	38	R441-028130-630	19
R410-027188-003	15	R439-034130-145	38	R441-028130-645	19
R410-040175-001	5	R439-034130-200	38	R441-034130-000	18
R410-040175-002	5	R439-034130-300	38	R441-034130-007	18
R410-040175-003	5	R439-034130-310	38	R441-034130-015	18
R411-040106-001	7	R440-028130-000	16	R441-034130-030	18
R411-040106-002	7	R440-028130-007	16	R441-034130-045	18
R411-040120-001	8	R440-028130-015	16	R441-034130-107	18
R411-040120-002	8	R440-028130-030	16	R441-034130-115	18
R411-040136-001	6	R440-028130-045	16	R441-034130-130	18
R411-040136-002	6	R440-028130-107	16	R441-034130-145	18
R411-040136-003	6	R440-028130-115	16	R441-034130-200	21

R441-034130-207.....	21	R443-034130-730.....	29	R450-028130-045.....	33
R441-034130-215.....	21	R443-034130-745.....	29	R450-028130-130.....	33
R441-034130-230.....	21	R443-034130-790.....	29	R450-028130-145.....	33
R441-034130-245.....	21	R443-034130-807.....	29	R450-034130-000.....	33
R441-034130-307.....	21	R443-034130-815.....	29	R450-034130-030.....	33
R441-034130-315.....	21	R443-034130-830.....	29	R450-034130-045.....	33
R441-034130-330.....	21	R443-034130-845.....	29	R450-034130-130.....	33
R441-034130-345.....	21	R444-034130-000.....	22	R450-034130-145.....	33
R441-034130-400.....	19	R444-034130-007.....	22	R450-034130-245.....	33
R441-034130-407.....	19	R444-034130-015.....	22	R450-034130-345.....	33
R441-034130-415.....	19	R444-034130-030.....	22	R451-034130-000.....	34
R441-034130-430.....	19	R444-034130-045.....	22	R451-034130-030.....	34
R441-034130-445.....	19	R444-034130-107.....	22	R451-034130-045.....	34
R441-034130-545.....	28	R444-034130-115.....	22	R451-034130-130.....	34
R441-034130-590.....	28	R444-034130-130.....	22	R451-034130-145.....	34
R441-034130-607.....	19	R444-034130-145.....	22	R452-034130-001.....	55
R441-034130-615.....	19	R444-034130-200.....	22	R452-034130-003.....	55
R441-034130-615.....	19	R444-034130-207.....	22	R452-034130-005.....	55
R441-034130-630.....	19	R444-034130-215.....	22	R452-034130-006.....	55
R441-034130-645.....	19	R444-034130-230.....	22	R452-042130-001.....	55
R441-034130-745.....	28	R444-034130-245.....	22	R452-042130-002.....	55
R441-034130-790.....	28	R444-034130-307.....	22	R452-042130-003.....	55
R442-028130-000.....	20	R444-034130-315.....	22	R452-042130-004.....	55
R442-028130-007.....	20	R444-034130-330.....	22	R452-042130-005.....	55
R442-028130-015.....	20	R444-034130-345.....	22	R452-042130-006.....	55
R442-028130-030.....	20	R444-034130-445.....	27	R452-042130-007.....	55
R442-028130-045.....	20	R446-034130-000.....	24	R452-042130-008.....	55
R442-028130-107.....	20	R446-034130-007.....	24	R452-042130-010.....	55
R442-028130-115.....	20	R446-034130-015.....	24	R452-055130-001.....	55
R442-028130-130.....	20	R446-034130-030.....	24	R452-055130-002.....	55
R442-028130-145.....	20	R446-034130-045.....	24	R452-055130-003.....	55
R442-034130-000.....	20	R446-034130-107.....	24	R452-055130-004.....	55
R442-034130-007.....	20	R446-034130-115.....	24	R452-055130-005.....	55
R442-034130-015.....	20	R446-034130-130.....	24	R452-055130-006.....	55
R442-034130-030.....	20	R446-034130-145.....	24	R452-055130-008.....	55
R442-034130-045.....	20	R446-034130-200.....	24	R452-055130-009.....	55
R442-034130-107.....	20	R446-034130-207.....	24	R452-055130-010.....	55
R442-034130-115.....	20	R446-034130-215.....	24	R453-034130-001.....	56
R442-034130-130.....	20	R446-034130-230.....	24	R453-034130-003.....	56
R442-034130-145.....	20	R446-034130-245.....	24	R453-034130-005.....	56
R443-034130-000.....	23	R446-034130-307.....	24	R453-034130-006.....	56
R443-034130-007.....	23	R446-034130-315.....	24	R453-042130-001.....	56
R443-034130-015.....	23	R446-034130-330.....	24	R453-042130-002.....	56
R443-034130-030.....	23	R446-034130-345.....	24	R453-042130-003.....	56
R443-034130-045.....	23	R446-045130-00 A.....	32	R453-042130-004.....	56
R443-034130-107.....	23	R446-045130-00 I.....	32	R453-042130-005.....	56
R443-034130-115.....	23	R446-045130-00 R.....	32	R453-042130-006.....	56
R443-034130-130.....	23	R447-034130-000.....	25	R453-042130-007.....	56
R443-034130-145.....	23	R447-034130-007.....	25	R453-042130-008.....	56
R443-034130-200.....	23	R447-034130-015.....	25	R453-042130-010.....	56
R443-034130-207.....	23	R447-034130-030.....	25	R454-034130-001.....	56
R443-034130-215.....	23	R447-034130-045.....	25	R454-034130-003.....	56
R443-034130-230.....	23	R447-034130-107.....	25	R454-034130-005.....	56
R443-034130-245.....	23	R447-034130-115.....	25	R454-034130-006.....	56
R443-034130-307.....	23	R447-034130-130.....	25	R454-042130-001.....	57
R443-034130-315.....	23	R447-034130-145.....	25	R454-042130-002.....	57
R443-034130-330.....	23	R448-034130-000.....	26	R454-042130-003.....	57
R443-034130-345.....	23	R448-034130-015.....	26	R454-042130-004.....	57
R443-034130-507.....	29	R448-034130-045.....	26	R454-042130-005.....	57
R443-034130-515.....	29	R448-034130-145.....	26	R454-042130-006.....	57
R443-034130-530.....	29	R448-034130-200.....	26	R454-042130-007.....	57
R443-034130-545.....	29	R448-035130-600.....	27	R454-042130-008.....	57
R443-034130-590.....	29	R448-035130-800.....	27	R454-042130-010.....	57
R443-034130-607.....	29	R449-035100-090.....	31	R454-055130-001.....	57
R443-034130-615.....	29	R449-035100-090 C.....	30	R454-055130-002.....	57
R443-034130-630.....	29	R449-035100-190.....	31	R454-055130-003.....	57
R443-034130-645.....	29	R449-035100-190 C.....	30	R454-055130-004.....	57
R443-034130-707.....	29	R450-028130-000.....	33	R454-055130-005.....	57
R443-034130-715.....	29	R450-028130-030.....	33	R454-055130-006.....	57

R454-055130-008.....	57	R492-030110-47.....	41
R454-055130-009.....	57	R492-030110-51.....	41
R454-055130-010.....	57	R492-030110-52.....	41
R455-034130-001.....	58	R494-030110-03.....	44
R455-034130-003.....	58	R494-030110-04.....	44
R455-034130-005.....	58	R494-030110-11.....	44
R455-034130-006.....	58	R494-030110-12.....	44
R455-042130-001.....	58	R494-030110-13.....	44
R455-042130-002.....	58	R494-030110-14.....	44
R455-042130-003.....	58	R494-030110-15.....	44
R455-042130-004.....	58	R494-030110-16.....	44
R455-042130-005.....	58	R494-030110-16.....	44
R455-042130-006.....	58	R494-030110-17.....	43
R455-042130-007.....	58	R494-030110-21.....	43
R455-042130-008.....	58	R494-030110-31.....	43
R455-042130-010.....	58	R494-030110-43.....	43
R455-055130-001.....	58	R494-030110-45.....	43
R455-055130-002.....	58	R494-030110-51.....	44
R455-055130-003.....	58	R494-030110-52.....	44
R455-055130-004.....	58		
R455-055130-005.....	58		
R455-055130-006.....	58		
R455-055130-008.....	58		
R455-055130-009.....	58		
R455-055130-010.....	58		
R470-045000-000.....	45		
R470-045083-000.....	45		
R470-045083-001.....	45		
R470-045083-002.....	45		
R480-020110-000.....	50		
R481-020110-000.....	50		
R485-020110-000.....	50		
R486-020110-000.....	50		
R487-020110-000.....	50		
R490-025110-43.....	49		
R490-030110-03.....	39		
R490-030110-05.....	39		
R490-030110-11.....	39		
R490-030110-12.....	39		
R490-030110-13.....	39		
R490-030110-14.....	39		
R490-030110-15.....	39		
R490-030110-16.....	39		
R490-030110-17.....	40		
R490-030110-21.....	40		
R490-030110-31.....	40		
R490-030110-32.....	40		
R490-030110-33.....	40		
R490-030110-43.....	40		
R490-030110-45.....	40		
R490-030110-47.....	40		
R490-030110-51.....	40		
R490-030110-52.....	40		
R492-000000-000.....	41		
R492-030110-00.....	42		
R492-030110-03.....	42		
R492-030110-04.....	42		
R492-030110-11.....	42		
R492-030110-12.....	42		
R492-030110-13.....	42		
R492-030110-14.....	42		
R492-030110-15.....	42		
R492-030110-16.....	42		
R492-030110-17.....	41		
R492-030110-21.....	41		
R492-030110-31.....	41		
R492-030110-32.....	41		
R492-030110-43.....	41		
R492-030110-45.....	41		

INDEX DEUTSCH

A
Antrumstanze 27
Arthroskope 4, 6, 10, 12, 47
Arthroskopieschäfte 5, 6, 7, 8, 11, 13, 15, 48
Adapter 51

B
Biopsiestanzen 28, 29, 36

C
Container 51, 53

E
Endoskope 4, 6, 10, 12, 47

F
Fadenzange 38
Faßzangen 35, 37

H
Hakenstanzen 16, 17, 18, 19
Hakenschere 33
Handinstrumente 39, 40, 41, 42, 43, 44

I
Inflow Kanüle 45
Instrumente für 2. Einstich 49, 50

O
Obturator 5, 6, 7, 8, 11, 13, 15, 45, 46, 48

R
Rotationszange 30, 31
Retraktor 37

S
Saugstanze 32
Schere 34
Shaver 55, 56, 57, 58
Spülkanüle 46
Stanzen 20, 21, 22, 23, 24, 25, 26, 27

T
Trokarhülse 5, 6, 7, 8, 11, 13, 15, 48

Z
Zangen 37
Zubehör 52, 53

INDEX ENGLISH

A
Accessories 52, 53
Antrum Punch 27
Arthroscopes 4, 6, 10, 12, 47
Arthroscopy Sheath 5, 6, 7, 8, 11, 13, 15, 48
Adapter 51

B
Biopsy punch 28, 29, 36

C
Container 51, 53

E
Endoscopes 4, 6, 10, 12, 47

F
Forceps 37

G
Grasper 35

H
Hand Instruments 39, 40, 41, 42, 43, 44
Hook Punches 16, 17, 18, 19
Hook Scissors 33

I
Inflow Cannula 45
Instruments for 2nd Puncture 49, 50
Irrigation Cannula 46

L
Ligature Forceps 38

O
Obturator 5, 6, 7, 8, 11, 13, 15, 45, 46, 48

P
Punches 20, 21, 22, 23, 24, 25, 26, 27

R
Rotary Punches 30, 31
Retraktor 37

S
Scissors 34
Shaver Blades 55, 56, 57, 58
Suction Punch 32

T
Trocar Sleeves 5, 6, 7, 8, 11, 13, 15, 48

INDICE ESPAÑOL

A	
Accesorios	52, 53
Artroscopios	4, 6, 10, 12, 47
Adaptador	51
C	
Canula Inflow	45
Canula de irrigacion	46
Contenedores	51, 53
E	
Endoscopios	4, 6, 10, 12, 47
I	
Instrumentos manuales	39, 40, 41, 42, 43, 44
Instrumentos para la	49, 50
segunda perforacion	
O	
Obturadores	5, 6, 7, 8, 11, 13, 15, 45, 46, 48
P	
Pinzas	16 – 32, 35 – 38
T	
Tijeras	33, 34
V	
Vainas	5, 6, 7, 8, 11, 13, 15, 48

Weitere Kataloge und Prospekte
Other cataloges and prospects

Hauptkatalog Chirurgische Instrumente
General catalog surgical instruments

Endoskopie
Endoscopy

Titan Instrumente
Titanium Instruments

Container Steriltechnik
Container Sterilization Technique

HERCULES® Drahtkneifzange
HERCULES® Wire Cutters

Neurochirurgie
Neuro surgery

Plastische Chirurgie
Plastic surgery

Orthopädie
Orthopedic



Gänsäcker 34
P.O. Box 131
D-78532 Tuttlingen
Germany



Fon +49 74 62.94 45-0
Fax +49 74 62.94 45-20
info@Reda-Instrumente.de
www.Reda-Instrumente.de